



INSTRUCTION MANUAL

VHF MARINE TRANSCEIVER IC-M422



Icom Inc.

FOREWORD

Thank you for purchasing this Icom product. The IC-M422 VHF MARINE TRANSCEIVERS are designed and built with Icom's state of the art technology and craftsmanship. With proper care, this product should provide you with years of trouble-free operation.

We want to take a couple of moments of your time to thank you for making the IC-M422 your radio of choice, and hope you agree with Icom's philosophy of "technology first." Many hours of research and development went into the design of your IC-M422.

◇ **FEATURES**

- *Simple operation with large keys*
- *Easy to hear speaker*
- *Built-in DSC meets RTCM SC101 requirement*
- *Rugged waterproof construction*
- *Optional COMMANDMIC II™*

Icom, Icom Inc. and the ICOM logo are registered trademarks of Icom Incorporated (Japan) in the United States, the United Kingdom, Germany, France, Spain, Russia and/or other countries. COMMANDMIC II is a trademark of Icom Incorporated (Japan) in the United states.

IMPORTANT

READ ALL INSTRUCTIONS carefully and completely before using the transceiver.

SAVE THIS INSTRUCTION MANUAL — This instruction manual contains important operating instructions for the IC-M422.

EXPLICIT DEFINITIONS

WORD	DEFINITION
⚠ WARNING!	Personal injury, fire hazard or electric shock may occur.
CAUTION	Equipment damage may occur.
NOTE	Recommended for optimum use. No risk of personal injury, fire or electric shock.

<p>CLEAN THE TRANSCEIVER AND MICROPHONE THOROUGHLY WITH FRESH WATER after exposure to water including salt water, otherwise, the keys and switches may become inoperable due to salt crystallization.</p>
--

IN CASE OF EMERGENCY

If your vessel requires assistance, contact other vessels and the Coast Guard by sending a Distress call on Channel 16.

USING CHANNEL 16

DISTRESS CALL PROCEDURE

1. "MAYDAY MAYDAY MAYDAY."
2. "THIS IS" (name of vessel)
3. Your call sign or other indication of the vessel (AND 9-digit DSC ID if you have one).
4. "LOCATED AT" (your position)
5. The nature of the distress and assistance required.
6. Any other information which might facilitate the rescue.

Or, transmit your Distress call using digital selective calling on Channel 70.

USING DIGITAL SELECTIVE CALLING (Ch 70)

DISTRESS CALL PROCEDURE

1. While lifting up the key cover, push and hold **[DISTRESS]** for 5 sec. until you hear 5 short beeps change to one long beep.
2. Wait for an acknowledgment on Channel 70 from a coast station.
 - After the acknowledgement is received, Channel 16 is automatically selected.
3. Push and hold **[PTT]**, then transmit the appropriate information as listed above.

NOTE

A WARNING STICKER is supplied with the transceiver. To comply with FCC regulations, this sticker must be affixed in such a location as to be readily seen from the operating controls of the radio as in the diagram below. Make sure the chosen location is clean and dry before applying the sticker. (p. 36)

EXAMPLE

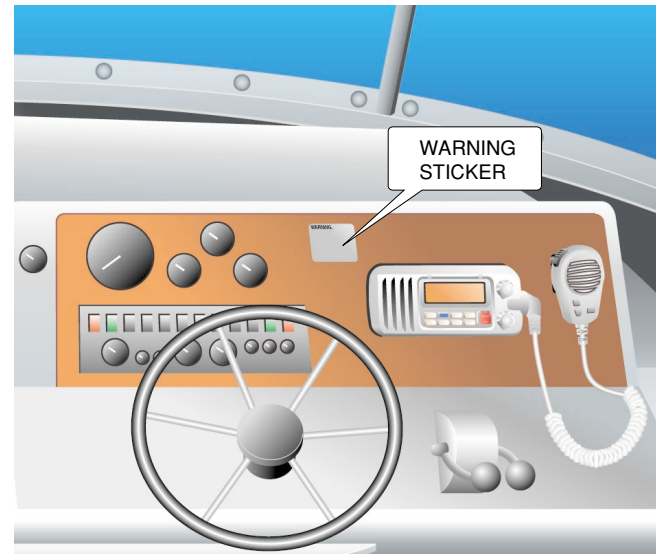

RADIO OPERATOR WARNING



Icom requires the radio operator to meet the FCC Requirements for Radio Frequency Exposure. An omnidirectional antenna with gain not greater than 9 dBi must be mounted a minimum of 5 meters (measured from the lowest point of the antenna) vertically above the main deck and all possible personnel. This is the minimum safe separation distance estimated to meet all RF exposure compliance requirements. This 5 meter distance is based on the FCC Safe Maximum Permissible Exposure (MPE) distance of 3 meters added to the height of an adult (2 meters) and is appropriate for all vessels.

For watercraft without suitable structures, the antenna must be mounted so as to maintain a minimum of 1 meter vertically between the antenna, (measured from the lowest point of the antenna), to the heads of all persons AND all persons must stay outside of the 3 meter MPE radius.

Do not transmit with radio and antenna when persons are within the MPE radius of the antenna, unless such persons (such as driver or radio operator) are shielded from antenna field by a grounded metallic barrier. The MPE Radius is the minimum distance from the antenna axis that person should maintain in order to avoid RF exposure higher than the allowable MPE level set by FCC.

FAILURE TO OBSERVE THESE LIMITS MAY ALLOW THOSE WITHIN THE MPE RADIUS TO EXPERIENCE RF RADIATION ABSORPTION WHICH EXCEEDS THE FCC MAXIMUM PERMISSIBLE EXPOSURE (MPE) LIMIT. IT IS THE RESPONSIBILITY OF THE RADIO OPERATOR TO ENSURE THAT THE MAXIMUM PERMISSIBLE EXPOSURE LIMITS ARE OBSERVED AT ALL TIMES DURING RADIO TRANSMISSION. THE RADIO OPERATOR IS TO ENSURE THAT NO BYSTANDERS COME WITHIN THE RADIUS OF THE MAXIMUM PERMISSIBLE EXPOSURE LIMITS.

Determining MPE Radius

THE MAXIMUM PERMISSIBLE EXPOSURE (MPE) RADIUS HAS BEEN ESTIMATED TO BE A RADIUS OF ABOUT 3M PER OET BULLETIN 65 OF THE FCC. THIS ESTIMATE IS MADE ASSUMING THE MAXIMUM POWER OF THE RADIO AND ANTENNAS WITH A MAXIMUM GAIN OF 9dBi ARE USED FOR A SHIP MOUNTED SYSTEM.

TABLE OF CONTENTS

FOREWORD	i	6 DSC OPERATION	13–29	12 COMMANDMIC II™ HM-157 ...	40–53
IMPORTANT	i	■ MMSI code programming	13	■ Panel description	40
EXPLICIT DEFINITIONS	i	■ MMSI code check	13	■ Function display	42
IN CASE OF EMERGENCY	ii	■ DSC Address ID	14	■ Channel selection	44
NOTE	ii	■ Position indication	15	■ Receiving and transmitting	45
RADIO OPERATOR WARNING.....	iii	■ Distress call	16	■ Call channel programming	46
TABLE OF CONTENTS	iv	■ Transmitting DSC calls.....	17	■ Lock functions	46
PRECAUTIONS	v	■ Receiving DSC calls.....	26	■ Display backlight	47
1 OPERATING RULES	1	7 OTHER FUNCTIONS	30–31	■ Monitor function.....	47
2 PANEL DESCRIPTION	2–4	■ Intercom operation	30	■ Dualwatch/Tri-watch operation ...	47
■ Front panel	2	■ Public Address (PA) function	31	■ Setting TAG channels	48
■ Microphone	3	■ RX Speaker function	31	■ Starting a scan	48
■ Function display	4	8 SET MODE	32–34	■ Set mode programming	49
3 BASIC OPERATION	5–9	■ Set mode programming	32	■ Intercom operation	50
■ Channel selection	5	■ Set mode items	32	■ Public Address function	50
■ Receiving and transmitting	7	9 CONNECTIONS AND		■ RX Speaker function	50
■ Call channel programming.....	8	MAINTENANCE	35–37	■ Channel comments	51
■ Channel comments.....	9	■ Connections	35	■ HM-157 supplied accessories.....	51
■ Microphone Lock function	9	■ Supplied accessories	36	■ Installation	52
■ Display backlight	9	■ Antenna	36	13 CHANNEL LIST	54
4 SCAN OPERATION	10–11	■ Fuse replacement.....	36	14 TEMPLATE	55
■ Scan types	10	■ Mounting the transceiver	36		
■ Setting TAG channels	11	■ Optional MB-69 installation	37		
■ Starting a scan	11	10 TROUBLESHOOTING.....	38		
5 DUALWATCH/TRI-WATCH.....	12	11 SPECIFICATIONS AND			
■ Description	12	OPTIONS	39		
■ Operation	12	■ Specifications	39		
		■ Options	39		

PRECAUTIONS

⚠ WARNING! NEVER connect the transceiver to an AC outlet. This may pose a fire hazard or result in an electric shock.

CAUTION: Changes or modifications to this device, not expressly approved by Icom Inc., could void your authority to operate this device under FCC regulations.

NEVER connect the transceiver to a power source of more than 16 V DC or use reverse polarity. This will ruin the transceiver.

NEVER cut the DC power cable between the DC plug at the back of the transceiver and fuse holder. If an incorrect connection is made after cutting, the transceiver may be damaged.

NEVER place the transceiver where normal operation of the vessel may be hindered or where it could cause bodily injury.

KEEP the transceiver at least 3.3 ft (1 m) away from the ship's navigation compass.

DO NOT use or place the transceiver in areas with temperatures below -4°F (-20°C) or above $+140^{\circ}\text{F}$ ($+60^{\circ}\text{C}$) or, in areas subject to direct sunlight, such as the dashboard.

AVOID the use of chemical agents such as benzine or alcohol when cleaning, as they may damage the transceiver surfaces. If the transceiver becomes dusty or dirty, wipe it clean with a soft, dry cloth.

BE CAREFUL! The transceiver rear panel will become hot when operating continuously for long periods.

Place the transceiver in a secure place to avoid inadvertent use by children.

BE CAREFUL! The transceiver and optional HM-157 COMMANDMIC II™ employ waterproof construction, which corresponds to IPX waterproof specification, Grade 7 (1 m/30 min.). However, once the transceiver or microphone has been dropped, waterproofing cannot be guaranteed due to the fact that the case may be cracked, or the waterproof seal damaged, etc.

◇ PRIORITIES

- Read all rules and regulations pertaining to priorities and keep an up-to-date copy handy. Safety and Distress calls take priority over all others.
- You must monitor Channel 16 when you are not operating on another channel.
- False or fraudulent distress signals are prohibited and punishable by law.

◇ PRIVACY

- Information overheard but not intended for you cannot lawfully be used in any way.
- Indecent or profane language is prohibited.

◇ RADIO LICENSES

(1) SHIP STATION LICENSE

You must have a current radio station license before using the transceiver. It is unlawful to operate a ship station which is not licensed.

Inquire through your dealer or the appropriate government agency for a Ship-Radiotelephone license application. This government-issued license states the call sign which is your craft's identification for radio purposes.

(2) OPERATOR'S LICENSE

A Restricted Radiotelephone Operator Permit is the license most often held by small vessel radio operators when a radio is not required for safety purposes.

The Restricted Radiotelephone Operator Permit must be posted or kept with the operator. Only a licensed radio operator may operate a transceiver.

However, non-licensed individuals may talk over a transceiver if a licensed operator starts, supervises, ends the call and makes the necessary log entries.

Keep a copy of the current government rules and regulations handy.

Radio license for boaters (U.S.A. only)

The Telecommunications Act of 1996 permits recreational boaters to have and use a VHF marine radio, EPIRB, and marine radar without having an FCC ship station license. Boaters traveling on international voyages, having an HF single sideband radiotelephone or marine satellite terminal, or required to carry a marine radio under any other regulation must still carry an FCC ship station license. For further information, see the FCC Ship Radio Stations Fact Sheet.

■ Front panel

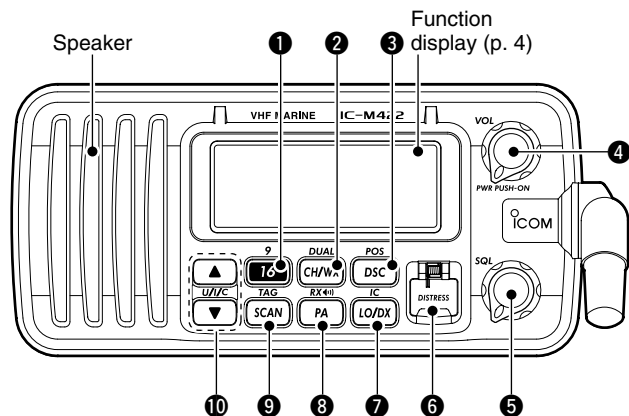

① CHANNEL 16/CALL CHANNEL KEY [16•9]

- ➔ Push to select Channel 16. (p. 5)
- ➔ Push for 1 sec. to select Call channel. (p. 5)
 - “CALL” appears when Call channel is selected.
- ➔ Push for 3 sec. to enter Call channel programming condition when Call channel is selected. (p. 8)
- ➔ While pushing [CH/WX•DUAL], push to enter the channel comment programming condition. (p. 9)
- ➔ Move the cursor backward while in the channel comment programming condition. (p. 9)
- ➔ While turning power ON, push to enter Set mode. (p. 32)

② CHANNEL/WEATHER CHANNEL KEY [CH/WX•DUAL]

- ➔ Selects and toggles the regular channel and Weather channel when pushed momentarily. (p. 6)
- ➔ Push for 1 sec. to start Dualwatch or Tri-watch. (p. 12)
- ➔ Push to stop Dualwatch or Tri-watch when either is activated. (p. 12)
- ➔ Advance the cursor while in the channel comment programming condition. (p. 9)

③ DSC/POSITION KEY [DSC•POS]

- ➔ Push to select the DSC menu. (p. 13)
- ➔ Push for 1 sec. to show the current position from a GPS receiver. (p. 15)

④ POWER/VOLUME CONTROL [VOL] (p. 7)

- ➔ Push for 2 sec. to turn power ON and OFF.
- ➔ Rotate to adjust the audio level.

⑤ SQUELCH CONTROL [SQL]

- ➔ Rotate to set the squelch threshold level. (p. 7)

⑥ DISTRESS KEY [DISTRESS]

- ➔ Push for 5 sec. to transmit a Distress call. (p. 16)

⑦ ATTENUATOR/INTERCOM KEY [LO/DX•IC]

- ➔ Push to toggle the Attenuator function ON or OFF. (p. 7)
 - “LOC” appears when the Attenuator function is turned ON.
- ➔ Push for 1 sec. to activate an optional Intercom function. (p. 30)
- ➔ Push and hold to calls the optional HM-157 COMMAND-MIC II™ while in Intercom mode. (p. 30)

- 8 PUBLIC ADDRESS/RX SPEAKER KEY [PA•RX ◀(1)]**

 - ➔ Push to turn the Public Address mode ON or OFF. (p. 31)
 - ➔ Push for 1 sec. to turn the RX Speaker mode ON or OFF. (p. 31)
- 9 SCAN KEY [SCAN•TAG] (p. 11)**

 - ➔ Push to start and stop Normal or Priority scan.
 - ➔ Push for 1 sec. to set or clear the displayed channel as a TAG (scanned) channel.
 - ➔ While pushing [HI/LO] on the microphone, push for 3 sec. to clear or set all TAG channels in the selected channel group.
- 10 CHANNEL UP/DOWN KEYS [▲]/[▼]•[U/I/C]**

 - ➔ Push to select the operating channels, Set mode settings, etc. (pgs. 5, 6, 32)
 - ➔ Push and hold [▲] to move upward through the operating channels continuously.
 - ➔ Push and hold [▼] to move downward through the operating channels continuously.
 - ➔ While pushing [SCAN•TAG], push [▲] or [▼] to adjust the brightness of the LCD and key backlight. (p. 9)
 - ➔ Push both keys to select one of three channel groups in sequence. (p. 6)
 - U.S.A., International and Canadian channels are available.
 - ➔ Checks TAG channels, changes scanning direction or resumes the scan manually during scan. (p. 11)
 - ➔ Push [▲] or [▼] to adjust the audio level in Public Address mode. (p. 31)
 - ➔ While pushing [PA•RX ◀(1)], push [▲] or [▼] to adjust the audio level in RX Speaker mode. (p. 31)

Microphone

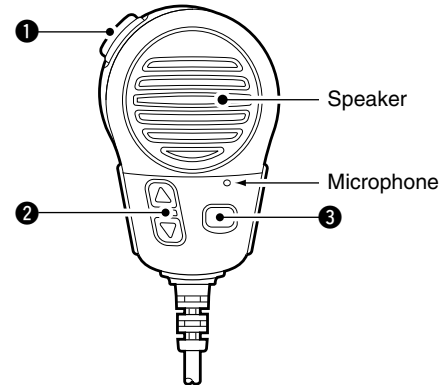

- 1 PTT SWITCH [PTT]**

 - ➔ Push and hold to transmit; release to receive. (p. 7)
- 2 CHANNEL UP/DOWN KEYS [▲]/[▼]**

 - ➔ Push either key to change the operating memory channel, Set mode settings, etc. (pgs. 5, 6, 32)
 - ➔ Checks TAG channels, changes scanning direction or resumes the scan manually during scan. (p. 11)
- 3 TRANSMIT POWER KEY [HI/LO]**

 - ➔ Toggles power high and low when pushed. (p. 7)
 - Some channels are set to low power only.
 - ➔ While pushing [HI/LO], turn power ON to toggle the Microphone Lock function ON and OFF. (p. 9)

2 PANEL DESCRIPTION

■ Function display

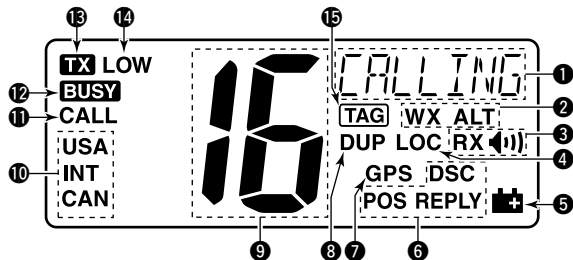

1 CHANNEL COMMENT INDICATOR

- ➔ Channel comment appears and scrolls if programmed. (p. 9)
- ➔ "DUAL" or "TW" blinks during Dualwatch or Tri-watch, respectively. (p. 12)
- ➔ "SCAN 16" or "SCAN" appears during Priority or Normal scan, respectively. (p. 11)
- ➔ In Set mode, indicates and scrolls the selected item. (p. 9)

2 WEATHER CHANNEL INDICATOR (pgs. 6, 33)

- ➔ "WX" appears when a weather channel is selected.
- ➔ "WX ALT" appears when the Weather Alert function is in use; blinks when an alert tone is received.

3 RX SPEAKER INDICATOR (p. 31)

Appears during the RX Speaker mode.

4 LOCAL INDICATOR (p. 7)

Appears when the Attenuator function is turned ON.

5 LOW BATTERY INDICATOR

Appears when the battery voltage drops to approx. 10 V DC or below.

6 DSC INDICATOR

Indicates the DSC status.

- "DSC" appears when a DSC call is received. (pgs. 25, 26)
- "POS REPLY" appears when a Position Request Reply call or Position Report Reply call is received. (pgs. 28, 29)

7 GPS INDICATOR

- ➔ Appears while valid position data is received.
- ➔ Blinks when invalid position data is received.
- ➔ Disappears when no GPS receiver is connected.

8 DUPLEX INDICATOR (p. 6)

Appears when a duplex channel is selected.

9 CHANNEL NUMBER READOUT

- ➔ Indicates the selected operating channel number.
 - "F" appears when a simplex channel is selected. (p. 6)
- ➔ In Set mode, indicates the selected condition. (p. 32)

10 CHANNEL GROUP INDICATOR (p. 6)

Indicates whether a U.S.A. "USA," International "INT" or Canadian "CAN" channel is in use.

11 CALL CHANNEL INDICATOR (p. 5)

Appears when the call channel is selected.

12 BUSY INDICATOR (p. 7)

Appears when receiving a signal or when the squelch opens.

13 TRANSMIT INDICATOR (p. 7)

Appears while transmitting.

14 LOW POWER INDICATOR (p. 7)

Appears when low power is selected.

15 TAG CHANNEL INDICATOR (p. 11)

Appears when a TAG channel is selected.

■ Channel selection

◇ Channel 16

Channel 16 is the distress and safety channel. It is used for establishing initial contact with another station and for emergency communications. Channel 16 is monitored during both Dualwatch and Tri-watch. While standing by, you must monitor Channel 16.

- ➔ Push [**16**•9] momentarily to select Channel 16.
- ➔ Push [**CH/WX**•DUAL] to return to the condition before selecting Channel 16, or push [**▲**] or [**▼**] to select an operating channel.



◇ Channel 9 (Call channel)

Each regular channel group has a separate leisure-use call channel. The call channel is monitored during Tri-watch. The call channels can be programmed (p. 8) and are used to store your most often used channel in each channel group for quick recall.

- ➔ Push [**16**•9] for 1 sec. to select the call channel of the selected channel group.
 - “CALL” and call channel number appear.
 - Each channel group may have an independent call channel after programming a call channel. (p. 8)
- ➔ Push [**CH/WX**•DUAL] to return to the condition before selecting call channel, or push [**▲**] or [**▼**] to select an operating channel.

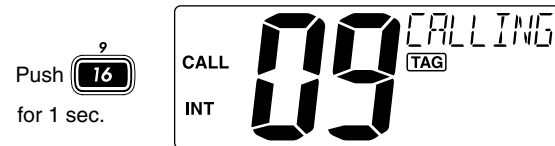

3 BASIC OPERATION

◆ U.S.A., international and Canadian channels

The IC-M422 is pre-programmed with 57 U.S.A., 57 international and 61 Canadian channels. These channel groups may be specified for the operating area.

- ① Push **[CH/WX•DUAL]** to select a regular channel.
 - If a weather channel appears, push **[CH/WX•DUAL]** again.
- ② Push both **[▲]** and **[▼]** on the transceiver to change the channel group, if necessary.
 - U.S.A., International and Canadian channel groups can be selected in sequence.
- ③ Push **[▲]** or **[▼]** to select a channel.
 - “**DUP**” appears for duplex channels.
 - “**H**” appears when a simplex channel is selected.

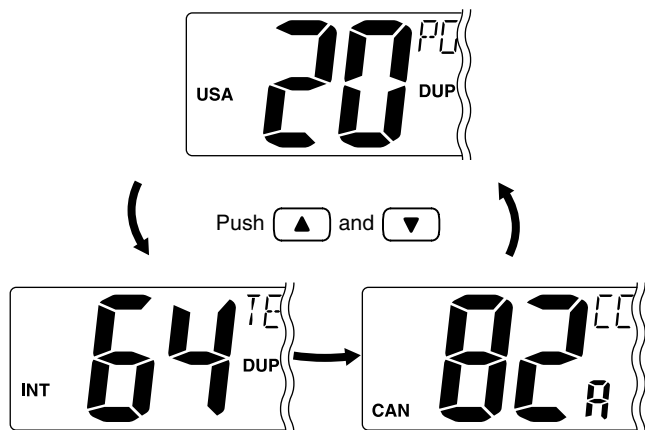

◆ Weather channels

The IC-M422 has 10 weather channels. These are used for monitoring broadcasts from NOAA (National Oceanographic and Atmospheric Administration.)

The transceiver can detect a weather alert tone on the selected weather channel while receiving the channel, during standby on a regular channel or while scanning. (p. 33)

- ① Push **[CH/WX•DUAL]** once or twice to select a weather channel.
 - “**WX**” appears when a weather channel is selected.
 - “**WX ALT**” appears when the Weather Alert function is in use. (p. 33)

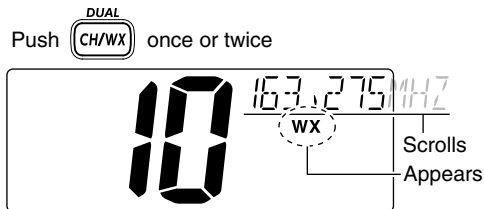

When Weather alert is OFF.

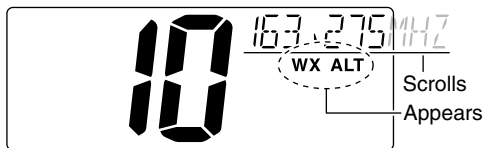

When Weather alert is ON.

- ② Push **[▲]** or **[▼]** to select a channel.

■ Receiving and transmitting

CAUTION: Transmitting without an antenna may damage the transceiver.

- ① Push **[VOL]** for 2 sec. to turn power ON.
- ② Set the audio and squelch levels.
 - ➔ Rotate **[SQL]** fully counterclockwise in advance.
 - ➔ Rotate **[VOL]** to adjust the audio output level.
 - ➔ Rotate **[SQL]** clockwise until the noise disappears.
- ③ To change the channel group, push both **[▲]** and **[▼]** on the transceiver. (p. 6)
- ④ Push **[▲]** or **[▼]** to select the desired channel. (pgs. 5, 6)
 - When receiving a signal, “**BUSY**” appears and audio is emitted from the speaker.
 - Further adjustment of **[VOL]** may be necessary.
- ⑤ Push **[LO/DX•IC]** to turn the receive Attenuator function ON or OFF, if necessary.
 - “**LOC**” appears when the receive Attenuator function is in use.
- ⑥ Push **[HI/LO]** to select the output power if necessary.
 - “**LOW**” appears when low power is selected.
 - Choose low power for short range communications, choose high power for longer distance communications.
 - Some channels are for low power only.
- ⑦ Push and hold **[PTT]** to transmit, then speak into the microphone (*).
 - “**TX**” appears.
 - Channel 70 cannot be used for transmission other than DSC.
- ⑧ Release **[PTT]** to receive.

Simplex channels, 3, 21, 23, 61, 64, 81, 82 and 83 **CANNOT** be lawfully used by the general public in U.S.A. waters.

IMPORTANT: To maximize the readability of your transmitted signal, pause a few sec. after pushing **[PTT]**, hold the microphone 2 to 4 inches (5 to 10 cm) from your mouth and speak into the microphone (*) at a normal voice level.

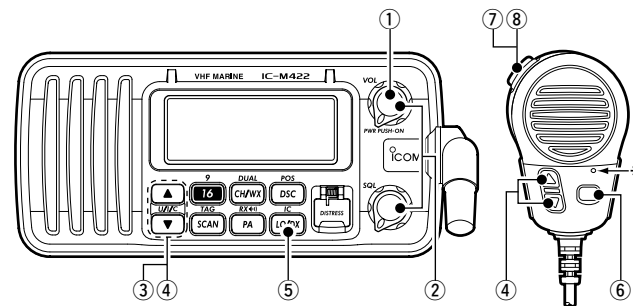

3 BASIC OPERATION

■ Call channel programming

Call channel is used to select Channel 9 (default), however, you can program the call channel with your most often-used channels in each channel group for quick recall.

- ① Push both [▲] and [▼] on the transceiver one or more times to select the desired channel group (U.S.A., International or Canada) to be programmed.



- ② Push [16•9] for 1 sec. to select the call channel of the selected channel group.
- "CALL" and call channel number appear.



- ③ Push [16•9] again for 3 sec. (until a long beep changes to 2 short beeps) to enter the call channel programming condition.
- Channel number starts blinking.



- ④ Push [▲] or [▼] to select the desired channel.

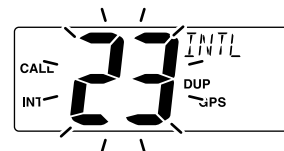

- ⑤ Push [16•9] to program the displayed channel as the call channel.
- Push [CH/WX•DUAL] to cancel.
 - The channel number stops blinking.

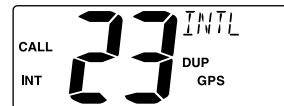

■ Channel comments

Memory channels can be labeled with alphanumeric comments of up to 10 characters each for easy channel recognition.

Comments more than 7 characters long automatically scroll at the channel comment indicator after the channel selection.

Capital letters, small letters (except f, j, k, p, s, v, x, z), 0 to 9, some symbols (= * + - . /) and space can be used.

- ① Select the desired channel.
 - Cancel Dualwatch, Tri-watch or Scan in advance.
- ② While pushing **[CH/WX•DUAL]**, push **[16•9]** to edit the channel comment.
 - A cursor and the first character start blinking alternately.
- ③ Select the desired character by pushing **[▲]** or **[▼]**.
 - Push **[CH/WX•DUAL]** or **[16•9]** to move the cursor forward or backward, respectively.
- ④ Repeat step ③ to input all characters.
- ⑤ Push **[DSC•POS]** to input and set the comment.
 - Push **[LO/DX•IC]** to cancel.
 - The cursor and the character stop blinking.
- ⑥ Repeat steps ① to ⑤ to program other channel comments, if desired.

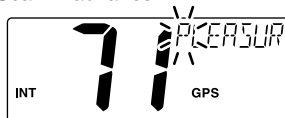

■ Microphone Lock function

The Microphone Lock function electrically locks **[▲]/[▼]** and **[HI/LO]** keys on the supplied microphone. This prevents accidental channel changes and function access.

- ➔ While pushing **[HI/LO]** on the microphone, turn power ON to toggle the Lock function ON and OFF.

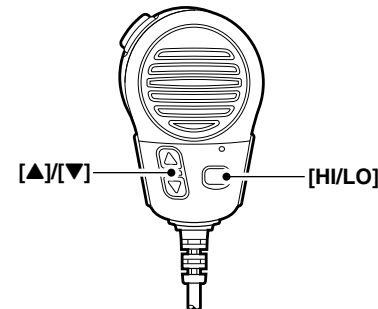

■ Display backlight

The function display and keys can be backlit for better visibility under low light conditions.

Display backlight is also adjustable via the Set mode. (p. 34)

- ➔ While pushing **[SCAN•TAG]**, push **[▲]** or **[▼]** to adjust the brightness of the LCD and key backlight.
 - The backlight is adjustable in 7 levels and OFF.

■ Scan types

Scanning is an efficient way to locate signals quickly over a wide frequency range. The transceiver has Priority scan and Normal scan.

When the Weather Alert function is turned ON, the previously selected (last used) weather channel is also checked while scanning. (p. 33)

PRIORITY SCAN

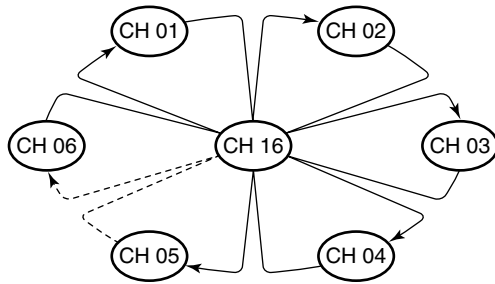

Priority scan searches through all TAG channels in sequence while monitoring Channel 16. When a signal is detected on Channel 16, scan pauses until the signal disappears; when a signal is detected on a channel other than Channel 16, scan becomes Dualwatch until the signal disappears.

Set the TAG channels (scanned channel) before scanning. Clear the TAG channels which inconveniently stop scanning, such as those for digital communication use. (Refer to right page for details.)

/// Choose Priority or Normal scan in Set mode. (p. 32)

NORMAL SCAN

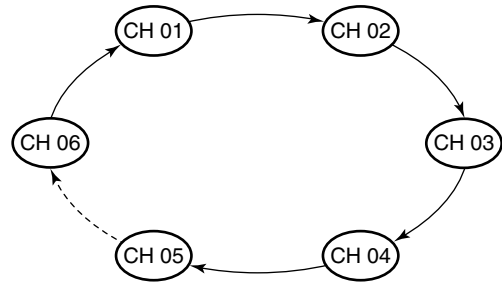

Normal scan, like Priority scan, searches through all TAG channels in sequence. However, unlike Priority scan, Channel 16 is not checked unless Channel 16 is set as a TAG channel.

■ Setting TAG channels

For more efficient scanning, add the desired channels as TAG channels or clear the TAG for unwanted channels. Channels that are not tagged will be skipped during scanning. TAG channels can be assigned to each channel group (USA, INT, CAN) independently.

- ① Push both [▲] and [▼] to select the desired channel group (USA, INT or CAN.)
- ② Select the desired channel to be set as a TAG channel.
- ③ Push [SCAN•TAG] for 1 sec. to set the displayed channel as a TAG channel.
 - "TAG" appears in the display.
- ④ To cancel the TAG channel setting, repeat step ③.
 - "TAG" disappears.

✓ Clearing (or setting) all tagged channels

While pushing [HI/LO] on the microphone, push [SCAN•TAG] for 3 sec. (until a long beep changes to 2 short beeps) to clear all TAG channels in the channel group.

- Repeat above procedure to set all TAG channels.

■ Starting a scan

Set scan type (Priority or Normal scan) and scan resume timer in advance, using Set mode. (p. 32)

- ① Push both [▲] and [▼] to select the desired channel group (USA, INT, CAN) if desired.
- ② Set TAG channels as described at left.
- ③ Make sure the squelch is closed to start a scan.
- ④ Push [SCAN•TAG] to start Priority or Normal scan.
 - "SCAN 16" appears at the channel comment indicator during Priority scan.
 - "SCAN" appears at the channel comment indicator during Normal scan.
 - When a signal is detected, scan pauses until the signal disappears or resumes after pausing 5 sec. according to Set mode setting. (Channel 16 is still monitored during Priority scan.)
 - Push [▲] or [▼] to check the scanning TAG channels, to change the scanning direction or resume the scan manually.
 - A beep tone sounds and "16" blinks at the channel comment indicator when a signal is received on Channel 16 during Priority scan.
- ⑤ To stop the scan, repeat step ④.

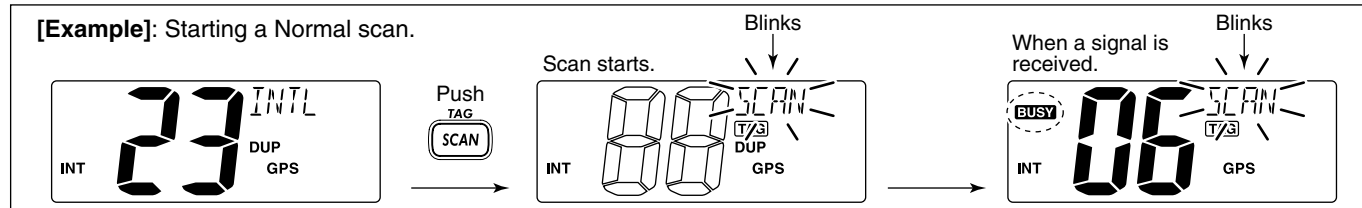

■ Description

Dualwatch monitors Channel 16 while you are receiving another channel; Tri-watch monitors Channel 16 and the call channel while receiving another channel. Dualwatch/Tri-watch is convenient for monitoring Channel 16 when you are operating on another channel.

DUALWATCH/TRI-WATCH SIMULATION



- If a signal is received on Channel 16, Dualwatch/Tri-watch pauses on Channel 16 until the signal disappears.
- If a signal is received on the call channel during Tri-watch, Tri-watch becomes Dualwatch until the signal disappears.
- To transmit on the selected channel during Dualwatch/Tri-watch, push and hold [PTT].

■ Operation

- ① Select Dualwatch or Tri-watch in Set mode. (p. 33)
- ② Push [▲] or [▼] to select the desired operating channel.
- ③ Push [CH/WX•DUAL] for 1 sec. to start Dualwatch or Tri-watch.
 - “TW” blinks during Dualwatch; “TW” blinks during Tri-watch.
 - A beep tone sounds when a signal is received on Channel 16.
- ④ To cancel Dualwatch/Tri-watch, push [CH/WX•DUAL] again.

[Example]: Operating Tri-watch on INT Channel 25

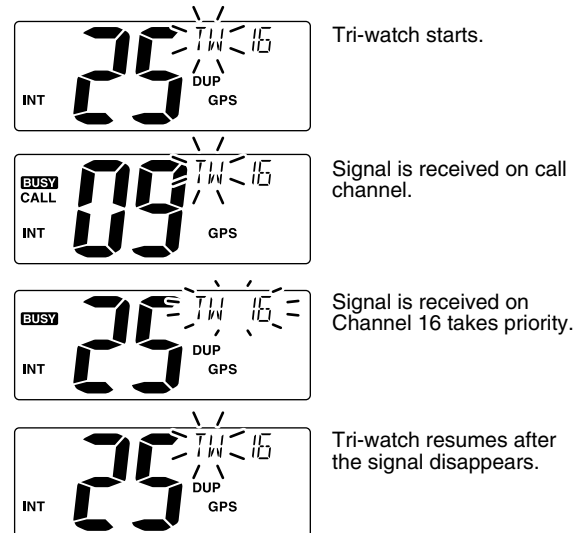

■ MMSI code programming

The 9-digit MMSI (Maritime Mobile Service Identity: DSC self ID) code can be programmed at power ON.

/// This function is not available when the MMSI code has been programmed by the dealer. This code programming can be performed only twice.

- ① Turn power OFF.
- ② While pushing **[DSC•POS]**, turn power ON to enter MMSI code programming condition.
- ③ After the display appears, release **[DSC•POS]**.
 - A cursor starts blinking.

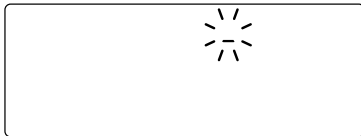

- ④ Enter the specified MMSI code by pushing **[▲]** or **[▼]**.
 - Push **[CH/WX•DUAL]** or **[16•9]** to move the cursor forward or backward, respectively.
- ⑤ Input 9-digit code, then push **[DSC•POS]** to set the code.
 - Returns to the normal operation.

■ MMSI code check

The 9-digit MMSI (DSC self ID) code can be checked.

- ① Push **[DSC•POS]** to enter the DSC menu.
- ② Push **[▲]** or **[▼]** to select “MMSI” and push **[DSC•POS]**.

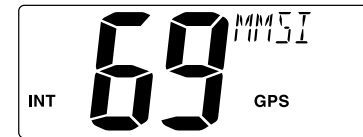

- ③ Check the 9-digit MMSI (DSC self ID) code.
 - The MMSI code is displayed and scrolls at the channel comment indicator.

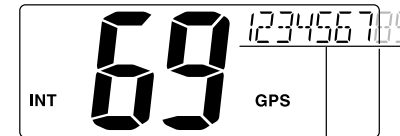

MMSI (DSC self ID) code scrolls

- ④ Push **[DSC•POS]** to exit the DSC menu.

6 DSC OPERATION

■ DSC Address ID

A total of 100 DSC address IDs (9-digit) can be programmed and named with up to 7 characters.

◇ Programming Address ID

- ① Push **[DSC•POS]** to enter the DSC menu.
- ② Push **[▲]** or **[▼]** to select "ADDRESS," push **[DSC•POS]**.



- ③ Push **[▲]** or **[▼]** to select "ADD," push **[DSC•POS]**.



- ④ Push **[▲]** or **[▼]** to set the 9-digit Individual/Group ID.
 - Push **[CH/WX•DUAL]** or **[16•9]** to move the cursor forward or backward, respectively.
 - Push **[LO/DX•IC]** to cancel and exit the condition.

/// 1st digit '0' is fixed for a Group ID. When you input 1st digit '0' and other 8 digits, the ID is automatically registered as a Group ID.



- ⑤ After entering the 9-digit code, push **[DSC•POS]** to set up to a 7-character ID name using **[▲]** or **[▼]**.
 - Push **[CH/WX•DUAL]** or **[16•9]** to move the cursor forward or backward, respectively.
 - Push **[LO/DX•IC]** to cancel and exit the condition.



- ⑥ Push **[DSC•POS]** to program and exit the DSC menu.

◇ Deleting Address ID

- ① Push [DSC•POS] to enter the DSC menu.
- ② Push [▲] or [▼] to select "ADDRESS," and push [DSC•POS].



- ③ Push [▲] or [▼] to select "DEL," push [DSC•POS].
 - When no address ID is programmed, "NO ID" is displayed.



- ④ Push [▲] or [▼] to select the desired ID name for deleting and push [DSC•POS].
 - "READY" appears.



- ⑤ Push [DSC•POS] to delete the address ID and exit the DSC menu.

■ Position indication

When a GPS receiver (NMEA0183 ver. 2.0 or 3.01) is connected, the transceiver displays the current position data in seconds of accuracy.

A NMEA0183 ver. 2.0 or 3.01 (sentence formatters RMC, GGA, GNS, GLL) compatible GPS receiver is required. Ask your dealer about suitable GPS receivers.

- Push [DSC•POS] for 1 sec. to display the current position.
 - 'Latitude' and 'Longitude' scroll in sequence at the channel comment indicator.
 - "NO POSITION" scrolls when no GPS is connected.

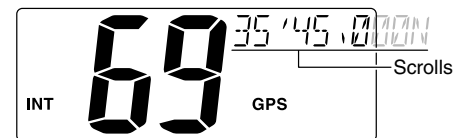

- When the connected GPS receiver is compatible with several sentence formatters, the order of input precedence is 'RMC,' 'GGA,' 'GNS' and 'GLL.'
- "GPS" blinks when the GPS data is invalid.

6 DSC OPERATION

■ Distress call

A Distress call should be transmitted, if in the opinion of the Master, the ship or a person is in distress and requires immediate assistance.

NEVER USE THE DISTRESS CALL WHEN YOUR SHIP OR A PERSON IS NOT IN AN EMERGENCY. A DISTRESS CALL CAN BE USED ONLY WHEN IMMEDIATE HELP IS NEEDED.

- ① Confirm no Distress call is being received.
- ② While lifting up the key cover, push **[DISTRESS]** for 5 sec. to transmit the Distress call.
 - Emergency channel (Ch 70) is automatically selected and the Distress call is transmitted.
 - While pushing **[DISTRESS]**, the key backlighting is blinking.



- ③ After transmitting the Distress call, the transceiver waits for an acknowledgment call on Ch70.
 - The Distress call is automatically transmitted every 3.5 to 4.5 minutes.
 - "DSC REPEAT" scrolls at the channel comment indicator.



- ④ After receiving the acknowledgment, reply using the microphone.
 - Channel 16 is automatically selected.
 - "REV DISTRESS ACK" scrolls at the channel comment indicator.

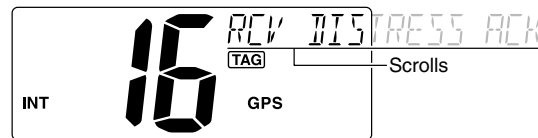

- A distress alert contains;
 - Kinds of distress: Undesignated distress
 - Position data : Latest GPS position data held for 23.5 hrs. or until the power is turned OFF.
- The Distress call is repeated every 3.5–4.5 min., until receiving an 'acknowledgement.'
- Push **[DISTRESS]** to transmit a renewed Distress call, if desired.
- Push **[16•9]** to cancel the 'Call repeat' mode.

■ Transmitting DSC calls

/// To ensure correct operation of the DSC function, please make sure you set the squelch correctly. (P. 7)

◇ Transmitting an Individual call

The Individual call function allows you to transmit a DSC signal to a specific ship only.

- ① Push [DSC•POS] to enter the DSC menu.
- ② Push [▲] or [▼] to select "INDIVIDUAL," push [DSC•POS].

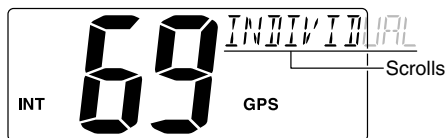

- ③ Push [▲] or [▼] to select the desired pre-programmed Individual address, push [DSC•POS].
 - The ID code must be set in advance. (p. 13)



- ④ Push [▲] or [▼] to select the desired intership channel, push [DSC•POS].
 - Intership channels are already preset into the transceiver in preferred order.
 - After pushing [DSC•POS], Channel 70 is selected and "READY" appears at the channel comment indicator.

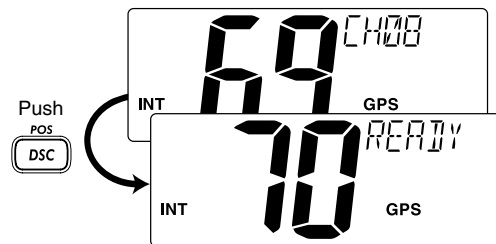

- ⑤ Push [DSC•POS] to transmit the Individual call.
 - If Channel 70 is busy, the transceiver stands by until the channel becomes clear.
 - Routine category only is available.



6 DSC OPERATION

- ⑥ Stands by on Channel 70 until an acknowledgement is received.

- “*WAIT ACK*” scrolls at the channel comment indicator.

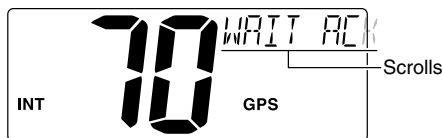

- ⑦ When the acknowledgement 'Able to comply' is received, the specified channel (in step ④) is selected with beeps automatically. Or, when the acknowledgement 'Unable to comply' is received, the display returns to the operated channel (before entering the DSC menu) with beeps.

- “*REV ABLE ACK*” or “*REV UNABLE ACK*” scrolls at the channel comment indicator.

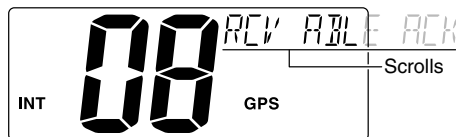

'Able to comply' is received.

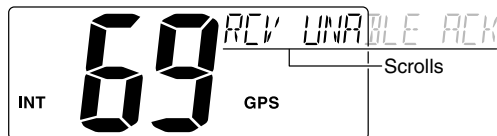

'Unable to comply' is received.

- ⑧ Push any key to stop the beep, then push and hold **[PTT]** to communicate your message to the responding ship.

◇ Transmitting an Individual acknowledgement

When receiving an Individual call, you can transmit an acknowledgement ('Able to comply' or 'Unable to comply') by using the on screen prompts (see page 26 for details). Alternatively, you can send an acknowledgement through the menu system as follows.

- ① Push **[DSC•POS]** to enter the DSC menu.
- ② Push **[▲]** or **[▼]** to select “*INDV ACK*,” push **[DSC•POS]**.
 - “*INDV ACK*” item appears after an Individual call is received.
 - “*INDV ACK*” item disappears if another call is received after the Individual call.
 - The Individual acknowledgement can be transmitted to the last received Individual call only.

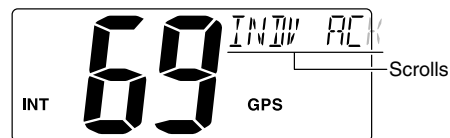

- ③ Push [▲] or [▼] to select the acknowledgement “ABLE” or “UNABLE.”

- When “UNABLE” is selected, the reason “No Reason Given” will be transmitted.



‘ABLE’ is selected.

- ④ Push [DSC•POS] to enter selected Individual call acknowledgement.

- “READY” appears at the channel comment indicator.



- ⑤ Push [DSC•POS] to transmit the acknowledgement call to the selected station.

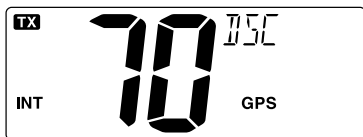

Transmitting

- ⑥ After the Individual acknowledgement call has been transmitted, the specified channel (specified by the calling station) is selected automatically when “ABLE” is selected, or returns to the previous condition (before entering the DSC menu) when “UNABLE” is selected in step ③.

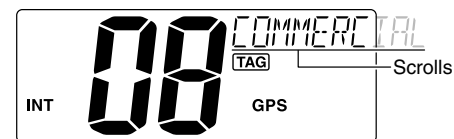

6 DSC OPERATION

◇ Transmitting a Group call

The Group call function allows you to transmit a DSC signal to a specific group only.

- ① Push **[DSC•POS]** to enter the DSC menu.
- ② Push **[▲]** or **[▼]** to select “GROUP,” push **[DSC•POS]**.



- ③ Push **[▲]** or **[▼]** to select the desired pre-programmed Group address, push **[DSC•POS]**.
 - The ID code must be set in advance. (p. 13)



- ④ Push **[▲]** or **[▼]** to select the desired intership channel, and push **[DSC•POS]**.
 - Intership channels are already preset into the transceiver in preferred order.
 - After pushing **[DSC•POS]**, Channel 70 is selected and “READY” appears at the channel comment indicator.

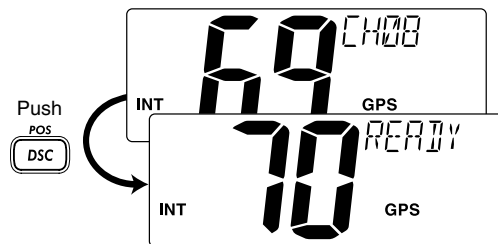

- ⑤ Push **[DSC•POS]** to transmit the Group call.
 - If Channel 70 is busy, the transceiver stands by until the channel becomes clear.
 - Routine category only is available.



- ⑥ After the Group call has been transmitted, the specified channel (in step ④) is selected automatically.

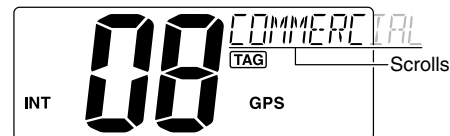

- ⑦ Push and hold **[PTT]** to communicate your message to the responding ship.

◇ **Transmitting an All Ships call**

Large ships use Channel 70 as their 'listening channel.' When you want to announce a message to these ships, use the 'All Ships call' function.

- ① Push **[DSC•POS]** to enter the DSC menu.
- ② Push **[▲]** or **[▼]** to select "ALL SHIPS."



- ③ Push **[DSC•POS]** to enter the standby condition for All Ships call.
 - Channel 70 is selected and "READY" appears at the channel comment indicator.



- ④ Push **[DSC•POS]** to transmit the All Ships call.
 - Routine category only is available.

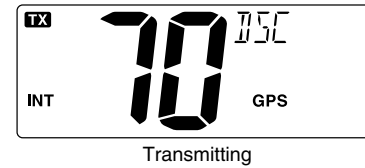

- ⑤ After the All Ships call has been transmitted, Channel 16 is selected automatically.



6 DSC OPERATION

◇ Transmitting a Position Request call

Transmit a Position Request call when you want to know a specified ship's current position, etc.

- ① Push **[DSC•POS]** to enter the DSC menu.
- ② Push **[▲]** or **[▼]** to select "POS REQUEST," push **[DSC•POS]**.

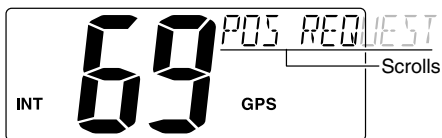

- ③ Push **[▲]** or **[▼]** to select the desired pre-programmed Individual address.
 - The ID code must be set in advance. (p. 13)



- ④ Push **[DSC•POS]** to enter the standby condition for Position Request call.
 - Channel 70 is selected and "READY" appears at the channel comment indicator.



- ⑤ Push **[DSC•POS]** to transmit the Position Request call.



- ⑥ After the Position Request call has been transmitted, the following indication is displayed.
 - "WAIT ACK" scrolls at the channel comment indicator.



- ⑦ Push any key to exit the condition and return to the previous indication before entering the DSC menu.

◇ Transmitting a Position Report call

Transmit a Position Report call when you want to announce your own position to a specific ship and to get an answer, etc.

- ① Push [DSC•POS] to enter the DSC menu.
- ② Push [▲] or [▼] to select “POS REPORT,” push [DSC•POS].



- ③ Push [▲] or [▼] to select the desired pre-programmed Individual address.
 - The ID code must be set in advance. (p. 13)



- ④ Push [DSC•POS] to enter the standby condition for Position Report call.
 - Channel 70 is selected and “READY” appears at the channel comment indicator.



- ⑤ Push [DSC•POS] to transmit the Position Report call.

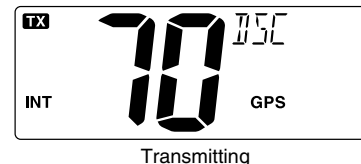

- ⑥ After the Position Report call has been transmitted, the following indication is displayed.
 - “WAIT ACK” scrolls at the channel comment indicator.

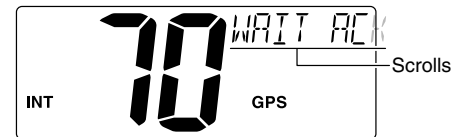

- ⑦ Push any key to exit the condition and return to the previous indication before entering the DSC menu.

6 DSC OPERATION

◇ Transmitting a Polling Request call

Transmit a Polling Request call when you want to know a specific ship is in the communication area, etc.

- ① Push **[DSC•POS]** to enter the DSC menu.
- ② Push **[▲]** or **[▼]** to select “*POLL REQUEST*,” push **[DSC•POS]**.

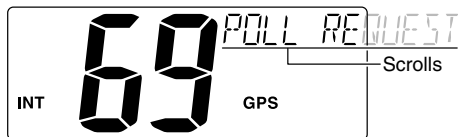

- ③ Push **[▲]** or **[▼]** to select the desired pre-programmed Individual address.
 - The ID code must be set in advance. (p. 13)



- ④ Push **[DSC•POS]** to enter the standby condition for Polling Request call.
 - Channel 70 is selected and “*READY*” appears at the channel comment indicator.



- ⑤ Push **[DSC•POS]** to transmit the Polling Request call.



- ⑥ After the Polling Request call has been transmitted, the following indication is displayed.
 - “*WAIT ACK*” scrolls at the channel comment indicator.

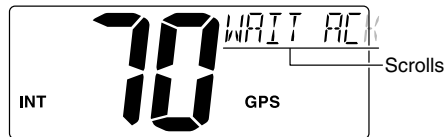

- ⑦ Push any key to exit the condition and return to the previous indication before entering the DSC menu.

◇ Transmitting a Position Request Reply call

Transmit a Position Request Reply call when a Position Request call is received.

- ① When a Position Request call is received, “DSC” appears and “RCV POS REQUEST” scrolls at the channel comment indicator.

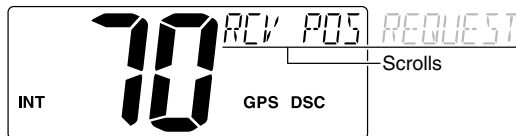

- ② Push **[DSC•POS]** to reply to the Position Request call; push other key to ignore the Position Request call.

◇ Transmitting a Position Report Reply call

Transmit a Position Report Reply call when a Position Report call is received.

- ① When a Position Report call is received, “DSC” appears and “RCV POS REPORT” scrolls at the channel comment indicator.



- ② Push **[DSC•POS]** to reply to the Position Report call; push other key to ignore the Position Report call.

◇ Transmitting a Polling Request Reply call

Transmit a Polling Request Reply call when a Polling Request call is received.

- ① When a Polling Request call is received, “DSC” appears and “RCV POLLING REQUEST” scrolls at the channel comment indicator.



- ② Push **[DSC•POS]** to reply to the Polling Request call; push other key to ignore the Polling Request call.

■ Receiving DSC calls

◇ Receiving a Distress call

While monitoring Channel 70 and a Distress call is received:

- ➔ The emergency alarm sounds for 2 minutes.
 - Push any key to stop the alarm.
- ➔ “DSC” appears and “*REV DISTRESS*” scrolls at the channel comment indicator, then Channel 16 is selected automatically.
- ➔ Continue monitoring Channel 16 as a coast station may require assistance.

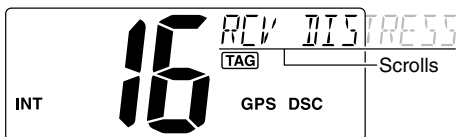

◇ Receiving a Distress Acknowledgement

While monitoring Channel 70 and a Distress acknowledgement to other ship is received:

- ➔ The emergency alarm sounds for 2 minutes.
 - Push any key to stop the alarm.
- ➔ “DSC” appears and “*REV DISTRESS ACK*” scrolls at the channel comment indicator, then Channel 16 is selected automatically.

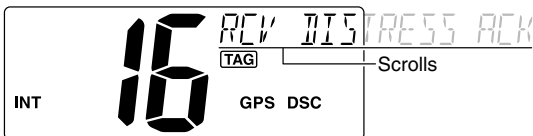

◇ Receiving a Distress Relay call

While monitoring Channel 70 and a Distress Relay acknowledgement is received:

- ➔ The emergency alarm sounds for 2 minutes.
 - Push any key to stop the alarm.
- ➔ “DSC” appears and “*REV RELAY*” scrolls at the channel comment indicator, then Channel 16 is selected automatically.



◇ Receiving an Individual call

While monitoring Channel 70 and an Individual call is received:

- ➔ The emergency alarm or beeps sound for 2 minutes depending on the received category.
 - Push any key to stop the alarm or beeps.
- ➔ “DSC” appears and “*REV INDIVIDUAL*” scrolls at the channel comment indicator.

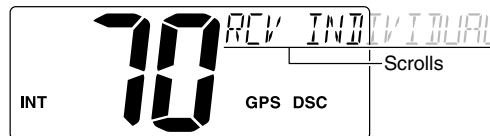

- ➔ Push [DSC•POS] to reply the call and select the channel specified by the calling station for voice communication (depending on your replying condition. See p. 18 for Individual acknowledgement call procedure for details.); push any other key to ignore the call.

◇ Receiving a Group call

While monitoring Channel 70 and a Group call is received:

- ➔ The emergency alarm or beeps sound for 2 minutes depending on the received category.
 - Push any key to stop the alarm or beeps.
- ➔ “DSC” appears and “*REV GROUP*” scrolls at the channel comment indicator.



- ➔ Push [DSC•POS] to select the channel specified by the calling station for voice communication; push any other key to ignore the call.

◇ Receiving an All Ships call

While monitoring Channel 70 and an All Ships call is received:

- ➔ The emergency alarm sounds for 2 minutes when the category is ‘Distress’ or ‘Urgency’; the beeps sound for 2 minutes for other categories.
 - Push any key to stop the alarm or beeps.
- ➔ “DSC” appears and “*REV ALL SHIPS*” scrolls at the channel comment indicator.



- ➔ Push [DSC•POS] to monitor Channel 16 for an announcement from the calling vessel, push any other key to ignore the call.

◇ Receiving a Geographical Area call

While monitoring Channel 70 and a Geographical Area call (for the area you are in) is received:

- ➔ The emergency alarm or beeps sound for 2 minutes depending on the received category.
 - Push any key to stop the alarm or beeps.
- ➔ “DSC” appears and “*REV GEOGRAPHICAL*” scrolls at the channel comment indicator.



- ➔ Push [DSC•POS] to select the channel specified by the calling station for voice communication; push any other key to ignore the call.
- ➔ Monitor the selected channel for an announcement from the calling station.

▧ When no GPS receiver is connected or if there is a problem with the connected receiver, all Geographical Area calls are received, regardless of your position.

6 DSC OPERATION

◇ Receiving a Position Request call

While monitoring Channel 70 and a Position Request call is received:

- ➔ “DSC” appears and “RCV POS REQUEST” scrolls at the channel comment indicator.
- ➔ The beeps sound for 2 minutes.
 - Push any key to stop the beeps.



- ➔ Push [DSC•POS] to reply to the call; push any other key to ignore the call.

◇ Receiving a Position Report call

While monitoring Channel 70 and a Position Report call is received:

- ➔ “DSC” appears and “RCV POS REPORT” scrolls at the channel comment indicator.
- ➔ The beeps sound for 2 minutes.
 - Push any key to stop the beeps.

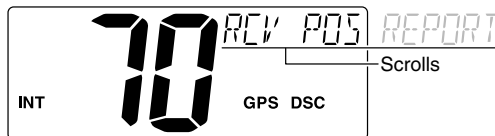

- ➔ Push [DSC•POS] to reply to the call; push any other key to ignore the call.

◇ Receiving a Polling Request call

While monitoring Channel 70 and a Polling Request call is received:

- ➔ “DSC” appears and “RCV POLLING REQUEST” scrolls at the channel comment indicator.
- ➔ The beeps sound for 2 minutes.
 - Push any key to stop the beeps.



- ➔ Push [DSC•POS] to reply to the call; push any other key to ignore the call.

◇ Receiving a Position Request Reply call

While monitoring Channel 70 and a Position Request Reply call is received:

- ➔ “DSC” and “POS REPLY” appear in the display.
 - The ‘Latitude’ and ‘Longitude’ from the called station is displayed and scrolled at the channel comment indicator in order of Latitude co-ordinates and then Longitude co-ordinates.
 - “NO POSITION” scrolls when no GPS is connected.
- ➔ The beeps sound for 2 minutes.
 - Push any key to stop the beeps.

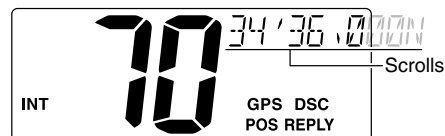

◇ Receiving a Position Report Reply call

While monitoring Channel 70 and a Position Report Reply call is received:

- ➔ “DSC” and “POS REPLY” appear in the display.
 - The ‘Latitude’ and ‘Longitude’ you have sent is displayed and scrolled at the channel comment indicator in order of Latitude co-ordinates and then Longitude co-ordinates.
 - “NO POSITION” scrolls when no GPS is connected.
- ➔ The beeps sound for 2 minutes.
 - Push any key to stop the beeps.

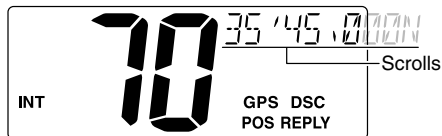

◇ Receiving a Polling Request Reply call

While monitoring Channel 70 and a Polling Request reply call is received:

- ➔ “DSC” appears and “REV POLLING REQ” scrolls at the channel comment indicator.
- ➔ The beeps sound for 2 minutes.
 - Push any key to stop the beeps.



- ➔ Push [DSC•POS] to reply to the call; push any other key to ignore the call.

■ Intercom operation

The optional Intercom function allows you to talk to the deck from the cabin. The optional HM-157 COMMANDMIC II™ is required for Intercom operation.

Connect an optional HM-157 as described on pgs. 35, 52.

- Transmitting is impossible during Intercom operation.
- The received signal is muted during Intercom operation.

- ① Push **[LO/DX•IC]** for 1 sec. to enter Intercom mode.
 - The HM-157 power is automatically turned ON, even if the power is OFF.



IC-M422

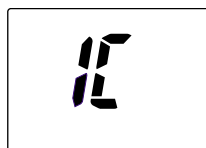

HM-157

- ② Push **[LO/DX•IC]** for 1 sec. again to call up the HM-157 side.
 - The transceiver and the HM-157 emit call beeps.
- ③ Push and hold **[PTT]** and speak at a normal voice level into the microphone.
 - “TALK” or “LSTN” appears on the caller or listener function display, respectively.
 - To adjust the IC-M422’s speaker output level, rotate **[VOL]**.
 - To adjust the HM-157’s speaker output level, push **[▲]** or **[▼]** after pushing **[VOL•DIM PA/RX ◀▶]** on the HM-157.



IC-M422 (caller)



HM-157 (listener)

- ④ After releasing **[PTT]** you can hear the response through the speaker.
 - ⑤ To return to the normal operation, push **[LO/DX•IC]** momentarily.
 - **[16•9]** and **[DISTRESS]** keys are also available.
- While in the Intercom mode, the transceiver functions (transmit and receive) are interrupted. If the transceiver is in transmit condition, the Intercom function is not available.
- When a DSC call is received, “DSC” appears and the DSC message is displayed at the channel comment indicator after the Intercom use is finished.
- When a WX alert is received, “WX ALT” blinks and a beep sounds. The WX alert sounds after the Intercom use is finished.

■ Public Address (PA) function

The IC-M422 has a Public Address function for voice amplification, making an announcement on-board via an external speaker or hailer.

Connect an external speaker or hailer as described on p. 35.
 • Transmitting is not possible during Public Address mode.

- ① Push **[PA•RX ◀▶]** to enter the Public Address mode.



- ② Push and hold **[PTT]** and speak at a normal voice level into the microphone.
 • “**TALK**” or “**WAIT**” appears at the channel comment indicator when **[PTT]** is pushed or released, respectively.
 • To adjust the audio output level, push **[▲]** or **[▼]**.
 ③ To return to normal operation, push **[PA•RX ◀▶]**.
 • **[16•9]** and **[DISTRESS]** keys are also available.

While in the Public Address mode, the transceiver functions (transmit and receive) are interrupted. If the transceiver is in transmit condition, the Public Address function is not available.

■ RX Speaker function

The IC-M422 has an RX Speaker function. When this function is turned ON, the received audio can be heard on the deck or tower via an external speaker or hailer.

Connect an external speaker or hailer as described on p. 35.

- ① Push **[PA•RX ◀▶]** for 1 sec. to enter the RX Speaker mode.
 • “**RX ◀▶**” appears
 • To adjust the audio output level, push **[▲]** or **[▼]** while pushing **[PA•RX ◀▶]**.

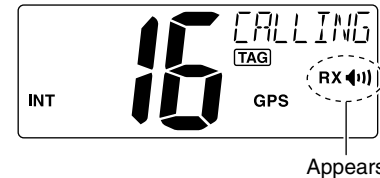

- ② To return to normal operation, push **[PA•RX ◀▶]** for 1 sec.

■ Set mode programming

Set mode is used to change the conditions of the transceiver's functions: Scan type, Scan resume timer, Weather alert, Dual/Tri-watch, DSC watch, Beep tone, LCD backlight, LCD contrast, Auto acknowledgement and Radio power.*

/// Available functions may differ depending on dealer setting.

- ① Turn power OFF.
- ② While pushing [16•9], turn power ON to enter Set mode.
 - "SCAN" appears at the channel comment indicator.
- ③ After the display appears, release [16•9].
- ④ Push [16•9] to select the desired item, if necessary.
- ⑤ Push [▲] or [▼] to select the desired condition of the item.
- ⑥ Turn power OFF, then ON again to exit Set mode.

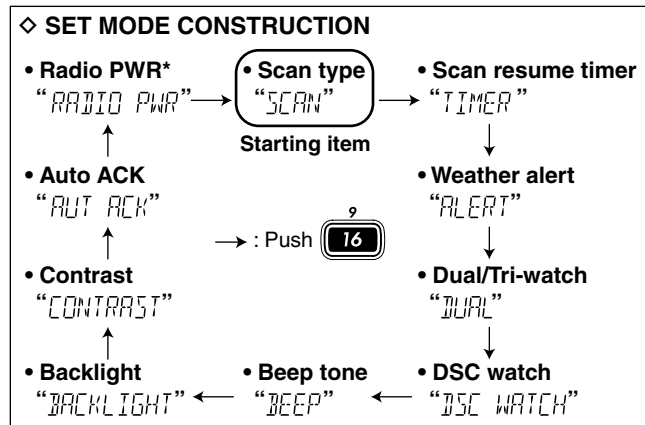

*Available only when optional HM-157 is connected.

■ Set mode items

◇ Scan type

The transceiver has 2 scan types: Normal scan and Priority scan. Normal scan searches all TAG channels in the selected channel group. Priority scan searches all TAG channels in sequence while monitoring Channel 16.

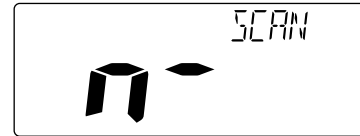

Normal scan (default)

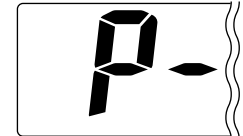

Priority scan

◇ Scan resume timer

The scan resume timer can be selected as a pause (OFF) or timer scan (ON). When OFF is selected, the scan pauses until the signal disappears. When ON is selected, the scan pauses 5 sec. and resumes even if a signal has been received on any other channel than Channel 16.



Scan timer OFF (default)



Scan timer ON

◆ Weather alert

A NOAA broadcast station transmits a weather alert tone before important weather information. When the Weather Alert function is turned ON, the transceiver detects the alert, then the “WX ALT” indicator blinks until the transceiver is operated. The previously selected (used) weather channel is checked any time during standby or while scanning.

- “WX ALT” appears instead of “WX” indication when the function is set ON.



Weather alert OFF (default)

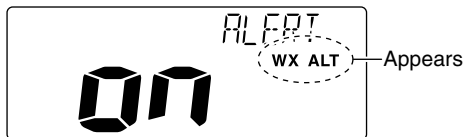

Weather alert ON

◆ Dual/Tri-watch

This item can be selected as Dualwatch or Tri-watch. (p. 12)

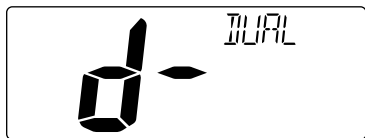

Dualwatch (default)

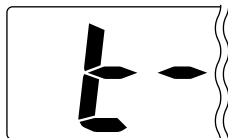

Tri-watch

◆ DSC watch

DSC watch monitors Channel 70 while you are receiving another channel.

If a distress signal is received on Channel 70, the transceiver monitors Channel 16 and 70 alternately until the distress signal disappears. If a signal is received on another channel, DSC watch pauses until the signal disappears.

- ▨ This function may not be available for some channel groups depending on dealer setting.

- “DSC WATCH” scrolls at the channel comment indicator.



DSC watch OFF (default)



DSC watch ON

◆ Beep tone

You can select the silent operation by turning beep tones OFF or you can have confirmation beeps sound at the push of a key by turning beep tones ON.



Beep tone ON (default)



Beep tone OFF

8 SET MODE

◆ LCD backlight

The LCD backlight brightness can be adjusted from OFF, 1 (dark) to 7 (bright.)

LCD backlight is also adjustable via [**SCAN•TAG**] key.
(p. 9)

➔ While pushing [**SCAN•TAG**],

- “**BACKLIGHT**” scrolls at the channel comment indicator.



LCD backlight level 7 (default)



LCD backlight OFF

◆ LCD contrast

The LCD contrast can be adjustable in 4 levels. 1 is the lowest contrast, and 4 is the highest contrast.

- “**CONTRAST**” scrolls at the channel comment indicator.

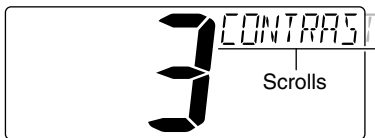

LCD contrast level 3 (default)

◆ Automatic acknowledgement

This item sets the automatic acknowledgement function ON or OFF. When Position Request, Position Report or Polling Request call is received, transceiver automatically transmits the reply call, respectively.

- “**AUTO ACK**” scrolls at the channel comment indicator.



Auto acknowledgement
OFF (default)



Auto acknowledgement
ON

◆ Radio power

(Available only when optional HM-157 is connected.)

This item sets the Radio Power function ON or OFF.

- “**RADIO PWR**” scrolls at the channel comment indicator.

ON : The transceiver's power is controlled by the HM-157. When the HM-157 is turned OFF, the transceiver will also be turned OFF automatically.

OFF : The transceiver's power is not controlled by the HM-157. Even if the HM-157 is turned OFF, the transceiver will continue to work.



Radio PWR ON (default)

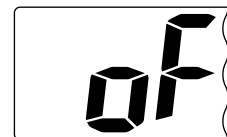

Radio PWR OFF

■ Connections

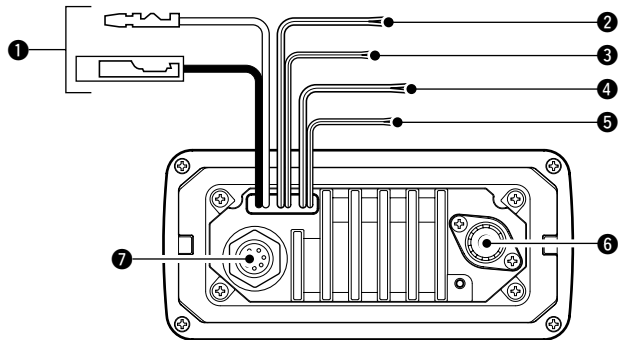

1 DC POWER CONNECTOR

Connects the supplied DC power cable from this connector to an external 12 V battery.

2 EXTERNAL SPEAKER LEAD (Yellow)

Connects to an external speaker or hailer speaker.

3 PUBLIC ADDRESS LEAD (Blue)

Connects to an external speaker or hailer speaker.

- PA output power: 4.5 W (typical) at 10% distortion with a 4 Ω load

4 NMEA IN LEAD (Red)

Connects to a GPS receiver for position indication.

- A NMEA0183 ver. 2.0 or 3.01 (sentence formatters RMC, GGA, GNS, GLL) compatible GPS receiver is required. Ask your dealer about suitable GPS receivers.

5 NMEA OUT LEAD (White)

Connects to a PC or navigation equipment (NMEA0183 ver. 3.01 sentence formatters DSC, DSE compatible) for plotting position data received from other ships.

6 ANTENNA CONNECTOR

Connects a marine VHF antenna with a PL-259 connector to the transceiver.

CAUTION: Transmitting without an antenna may damage the transceiver.

7 EXTERNAL MICROPHONE JACK

Connects to optional HM-157 COMMANDMIC II™.

CAUTION: After connecting the DC power cable, NMEA IN/OUT leads, external speaker lead and public address lead, cover the connector and leads with an adhesive tape as shown below, to prevent water seeping into the transceiver.

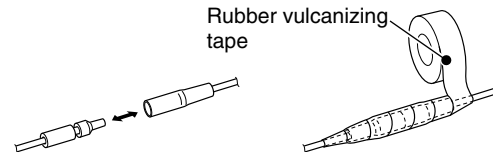

■ Supplied accessories

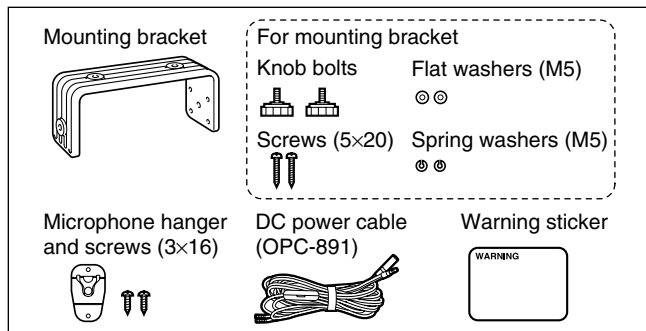

■ Antenna

A key element in the performance of any communication system is the antenna. Ask your dealer about antennas and the best place to mount them.

■ Fuse replacement

One fuse is installed in the supplied DC power cable. If a fuse blows or the transceiver stops functioning, track down the source of the problem, if possible, and replace the damaged fuse with a new one of the proper rating.

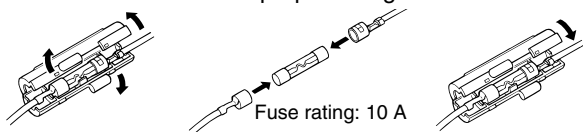

■ Mounting the transceiver

◆ Using the supplied mounting bracket

The universal mounting bracket supplied with your transceiver allows overhead or dashboard mounting.

- Mount the transceiver securely with the 2 supplied screws (5 × 20) to a surface which is more than 10 mm thick and can support more than 5 kg.
- Mount the transceiver so that the face of the transceiver is at 90° to your line of sight when operating it.

CAUTION: KEEP the transceiver and microphone at least 1 meter away from your vessel's magnetic navigation compass.

NOTE: Check the installation angle; the function display may not be easy-to-read at some angles.

EXAMPLE

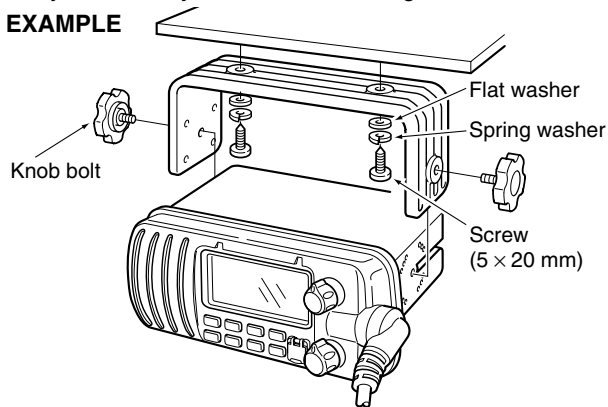

■ Optional MB-69 installation

An optional MB-69 FLUSH MOUNT is available for mounting the transceiver to a flat surface such as an instrument panel.

CAUTION: KEEP the transceiver and microphone at least 1 meter away from your vessel's magnetic navigation compass.

- ① Using the template on p. 55, carefully cut a hole into the instrument panel (or wherever you plan to mount the transceiver.)
- ② Slide the transceiver through the hole as shown below.

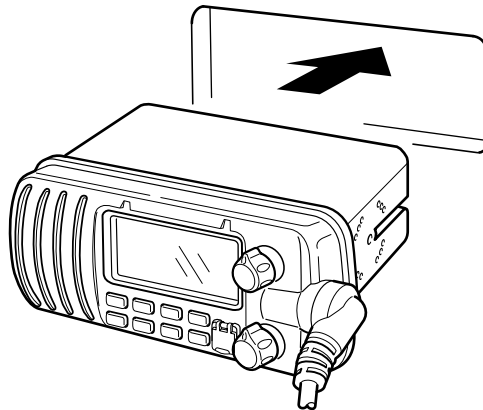

- ③ Attach the clamps on either side of the transceiver with 2 supplied bolts (5×8 mm).
 - Make sure that the clamps align parallel to the transceiver body.

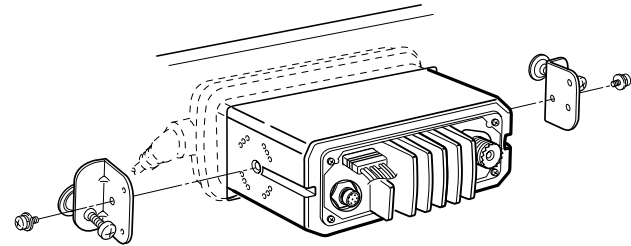

- ④ Tighten the end bolts on the clamps (rotate clockwise) so that the clamps press firmly against the inside of the instrument control panel.
- ⑤ Tighten the locking nuts (rotate counterclockwise) so that the transceiver is securely mounted in position as below.
- ⑥ Connect the antenna and power cable, then return the instrument control panel to its original place.

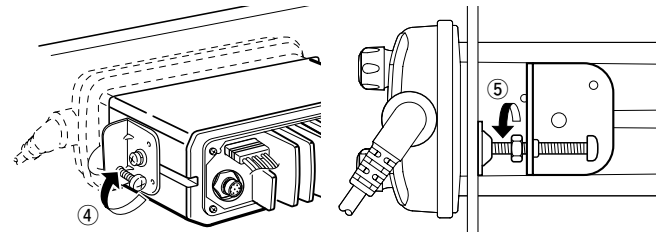

10 TROUBLESHOOTING

PROBLEM	POSSIBLE CAUSE	SOLUTION	REF.
The transceiver does not turn ON.	<ul style="list-style-type: none">• Bad connection to the power supply.	<ul style="list-style-type: none">• Check the connection to the transceiver.	p. 35
No sound from speaker.	<ul style="list-style-type: none">• Squelch level is too high.• Volume level is too low.• Speaker has been exposed to water.	<ul style="list-style-type: none">• Set [SQL] to the threshold point.• Set [VOL] to a suitable level.• Drain water from the speaker.	p. 7 p. 7 —
Sensitivity is low.	<ul style="list-style-type: none">• The Attenuator is activated.	<ul style="list-style-type: none">• Push [LO/DX•IC] to turn the function OFF.	p. 7
Transmitting is impossible, or high power can not be selected.	<ul style="list-style-type: none">• Some channels are for low power or receive only.• The output power is set to low.	<ul style="list-style-type: none">• Change channels.• Push [HI/LO] on the microphone to select high power.	pgs. 5, 6, 54 p. 7
Scan does not start.	<ul style="list-style-type: none">• TAG channel is not programmed.	<ul style="list-style-type: none">• Set the desired channels as TAG channels.	p. 11
No beeps.	<ul style="list-style-type: none">• Beep tones are turned OFF.• The squelch is open.	<ul style="list-style-type: none">• Turn the beep tone ON in Set mode.• Set [SQL] to the threshold point.	p. 33 p. 7
Distress call cannot be transmitted.	<ul style="list-style-type: none">• MMSI (DSC self ID) code is not programmed.	<ul style="list-style-type: none">• Program the MMSI (DSC self ID) code.	p. 13

■ Specifications

◆ General

- Frequency coverage : Tx 156.025–157.425 MHz
Rx 156.050–163.275 MHz
- Mode : FM (16K0G3E), DSC (16K0G2B)
- Channel spacing : 25 kHz
- Current drain (at 13.8 V) : TX high 5.5 A max.
Max. audio 1.5 A max.
- Power supply requirement : 13.8 V DC
- Frequency stability : ±10 ppm
(–20°C to +60°C; –4°F to +140°F)
- Dimensions : 164(W) × 78(H) × 139.3(D) mm
(Projections not included) 6 15/32(W) × 3 1/16(H) × 5 15/32(D) in
- Weight : Approx. 1070 g; 2.4 lb

◆ Transmitter

- Output power : 25 W/1 W
- Modulation system : Variable reactance frequency modulation
- Max. frequency deviation : ±5.0 kHz
- Spurious emissions : Less than –70 dBc

◆ Receiver

- Receive system : Double conversion superheterodyne
- Sensitivity (12 dB SINAD) : 0.22 μV (typical)
- Squelch sensitivity : 0.22 μV
- Intermodulation rejection ratio : More than 70 dB
- Spurious response rejection ratio : More than 70 dB
- Adjacent channel selectivity : More than 70 dB
- Audio output power : 4.5 W (typical) at 10% distortion with a 4 Ω load

All stated specifications are subject to change without notice or obligation.

◆ Dimensions

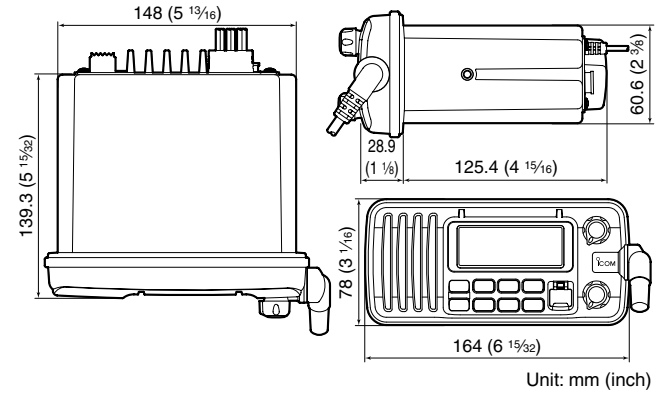

■ Options

- **MB-69** FLUSH MOUNT KIT
For mounting the transceiver to a panel.
- **HM-157** COMMANDMIC II™
External microphone-type controller. Provides optional inter-com operation. 6 m (20 feet) microphone cable and mounting base included. Black and white colors are available.
- **OPC-999** MICROPHONE EXTENSION CABLE
6 m (20 feet) microphone extension cable for optional HM-157 COMMANDMIC II™. Up to 2 OPC-999 can be connected. (18 m; 60 feet maximum)

12 COMMANDMIC II™ HM-157

■ Panel description

The optional HM-157 remotely controls the IC-M422 and provides an optional Intercom function.

◇ Front and side keys

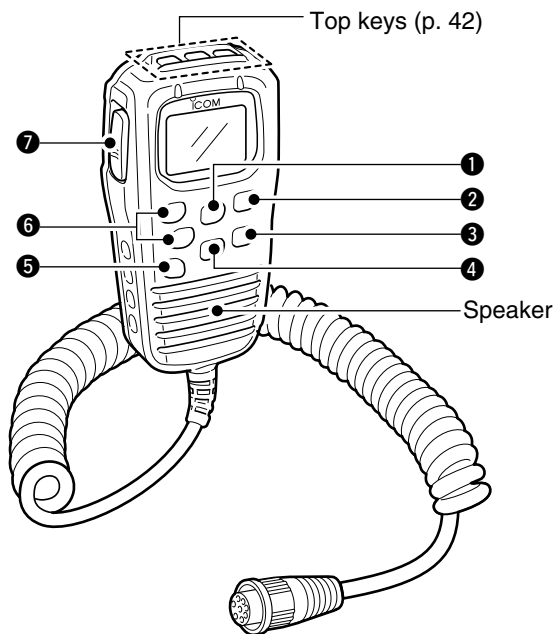

① VOLUME/DIMMER/PA/RX SPEAKER KEY

[VOL • DIM PA/RX ◀▶]

- ➔ Push [▲] or [▼] to adjust the audio level after pushing [VOL • DIM PA/RX ◀▶] (p. 45)
- ➔ Push [▲] or [▼] to adjust the brightness of the LCD and key backlight after pushing [VOL • DIM PA/RX ◀▶] for 1 sec. (p. 47)
- ➔ Move the cursor backward while in the channel comment programming condition. (p. 51)
- ➔ While pushing [H/L], push to turn the Public Address mode ON or OFF. (p. 50)
- ➔ While pushing [H/L], push for 1 sec. to turn the RX Speaker mode ON or OFF. (p. 50)

② SQUELCH/MONITOR/LOCK KEY [SQL • MONI L]

- ➔ Push [▲] or [▼] to set the squelch threshold level after pushing [SQL • MONI L]. (p. 45)
- ➔ Push for 1 sec. to turn the monitor function ON. (p. 47)
- ➔ While pushing [H/L], push [SQL • MONI L] to toggle the (microphone) Key Lock function ON or OFF. (p. 46)
 - “**L**” appears while (microphone) Key Lock function is in use.
 - [PWR], [PTT], [VOL], [SQL] and [H/L] still function when the (microphone) Key Lock function is turned ON.
- ➔ Advance the cursor while in channel comment programming condition. (p. 51)

③ ATTENUATOR/INTERCOM/SCRAMBLER KEY**[LO/DX • IC SCR]**

- Push to toggle the Attenuator function ON or OFF. (p. 45)
 - “LOCAL” appears when the Attenuator function is turned ON.
- Push for 1 sec. to activate the Intercom function. (p. 50)
- Calls the IC-M422 when pushed and held while in Intercom mode. (p. 50)

NOTE: Voice scrambler is not available for the IC-M422.

④ CHANNEL/DUALWATCH/TRI-WATCH KEY**[CH/WX • DW U/I/C]**

- Push to select and toggle the regular channels and weather channels. (p. 44)
- While pushing [H/L], push to select one of three channel groups in sequence. (p. 44)
 - U.S.A., International and Canadian channels are available.
- Push for 1 sec. to start Dualwatch or Tri-watch. (p. 47)
- Push to stop Dualwatch or Tri-watch when either is activated. (p. 47)

⑤ CHANNEL 16/CALL CHANNEL KEY [16•9]

- Push to select Channel 16. (p. 44)
- Push for 1 sec. to select call channel. (p. 44)
 - “CALL” appears when call channel is selected.
- Push for 3 sec. to enter call channel programming condition when call channel is selected. (p. 46)

- While pushing [CH/WX • DW U/I/C], push to enter the channel comment programming condition. (p. 51)
- While turning power ON, push to enter Set mode. (p. 49)

⑥ CHANNEL UP/DOWN KEYS [▲]/[▼]

- Push to select the operating channel, Set mode settings, etc. (pgs. 44, 49)
- Push and hold [▲] to move upward through the operating channels continuously.
- Push and hold [▼] to move downward through the operating channels continuously.
- Push [▲] or [▼] to adjust audio level or noise squelch level after pushing [VOL • DIM PA/RX ◀] or [SQL • MONI L], respectively. (p. 45)
- Push [▲] or [▼] to adjust the brightness of the LCD and key backlight after pushing [VOL • DIM PA/RX ◀] for 1 sec. (p. 47)
- Checks TAG channels or changes scanning direction during scan. (p. 48)
- Push [▲] or [▼] to adjust the audio level during in Public Address mode. (p. 50)
- While pushing [VOL • DIM PA/RX ◀], push [▲] or [▼] to adjust the audio level during in RX Speaker mode. (p. 50)

⑦ PTT SWITCH [PTT] (p. 45)

- Push and hold to transmit; release to receive.

◆ Top keys

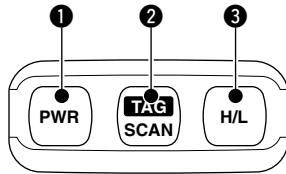

❶ POWER KEY [PWR] (p. 45)

Push for 2 sec. to turn the HM-157 power ON or OFF when the IC-M422 power is turned ON.

❷ SCAN KEY [SCAN • TAG] (p. 48)

- ➔ Push to start and stop Normal or Priority scan when TAG channels are programmed.
- ➔ Push for 1 sec. to set the displayed channel as a TAG (scanned) channel.
- ➔ While pushing [H/L], push for 3 sec. to clear or set all TAG channels.

❸ TRANSMIT POWER KEY [H/L]

- ➔ Push to toggle high or low power. (p. 45)
 - Some Channels are set to low power only.
- ➔ While pushing this key, other keys perform secondary functions.
- ➔ While turning power ON, push to toggle the All key Lock function ON or OFF. (p. 46)
 - “**L**” blinks while the All key Lock function is in use.
 - Only [PWR] and [PTT] are functional when the All key Lock function is in use.

■ Function display

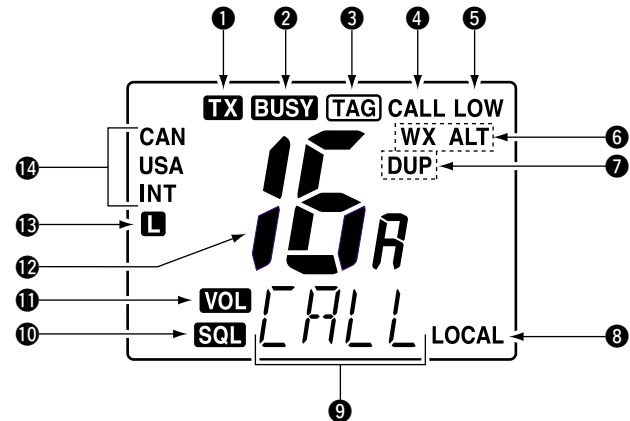

❶ TRANSMIT INDICATOR (p. 45)

Appears while transmitting.

❷ BUSY INDICATOR (p. 45)

Appears when receiving a signal or when the squelch opens.

❸ TAG CHANNEL INDICATOR (p. 48)

Appears when a TAG channel is selected.

❹ CALL CHANNEL INDICATOR (p. 46)

Appears when call channel is selected.

❺ LOW POWER INDICATOR (p. 45)

Appears when low power is selected.

- ⑥ **WEATHER CHANNEL INDICATOR** (pgs. 33, 44)
 - “WX” appears when a weather channel is selected.
 - “WX ALT” appears when the Weather Alert function is in use; blinks when an alert tone is received.
- ⑦ **DUPLEX INDICATOR** (p. 44)

Appears when a duplex channel is selected.
- ⑧ **LOCAL INDICATOR** (p. 45)

Appears when the Attenuator function is turned ON.
- ⑨ **CHANNEL COMMENT INDICATOR**
 - Channel comment appears (and scrolls) if programmed. (p. 51)
 - “*DW*” or “*TW*” blinks during Dualwatch or Tri-watch, respectively. (p. 47)
 - “*SCAN 16*” or “*SCAN*” appears during Priority or Normal scan, respectively. (p. 48)
 - In Set mode, indicates and scrolls the selected item. (p. 49)
- ⑩ **SQUELCH INDICATOR** (p. 45)

Appears while noise squelch level is adjusted.
- ⑪ **VOLUME INDICATOR** (p. 45)

Appears while audio output level is adjusted.
- ⑫ **CHANNEL NUMBER READOUT**
 - Indicates the selected operating channel number.
 - “R” appears when a simplex channel is selected. (p. 44)
 - In Set mode, indicates the selected condition. (p. 49)
- ⑬ **KEY LOCK INDICATOR** (p. 46)
 - Appears while the Key Lock function is in use.
 - Blinks while the All Key Lock function is in use.
- ⑭ **CHANNEL GROUP INDICATOR** (p. 44)

Indicates whether an U.S.A. “USA,” International “INT” or Canadian “CAN” channel is selected.

■ Channel selection

◆ Channel 16

- ① Push [**16•9**] to select Channel 16.
- ② Push [**CH/WX**] to return to the condition before selecting Channel 16, or push [**▲**] or [**▼**] to select an operating channel.

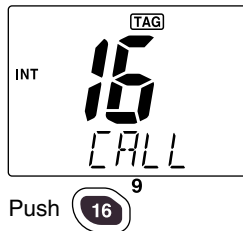

◆ Call channel

- ① Push [**16•9**] for 1 sec. to select call channel.
- ② Push [**CH/WX**] to return to the condition before selecting call channel, or push [**▲**] or [**▼**] to select an operating channel.

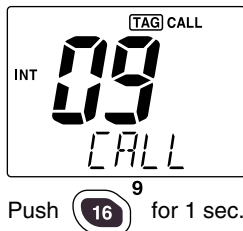

◆ Weather channels

- ① Push [**CH/WX**] once or twice to select the weather channel group.
- ② Push [**▲**] or [**▼**] to select a weather channel.
- ③ Push [**CH/WX**] to return to the condition before selecting the weather channel group.

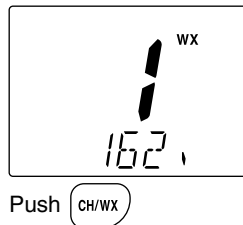

◆ U.S.A., International and Canadian channels

- ① Push [**CH/WX•DW U/I/C**] to select a regular channel.
 - Push [**CH/WX•DW U/I/C**] again, if a weather channel appears.
- ② While pushing [**H/L**], push [**CH/WX•DW U/I/C**] to select a channel group.
 - U.S.A., International and Canadian channels can be selected in sequence.
- ③ Push [**▲**] or [**▼**] to select a channel.
 - “**DUP**” appears for duplex channels.
 - “**R**” appears when a simplex channel is selected.

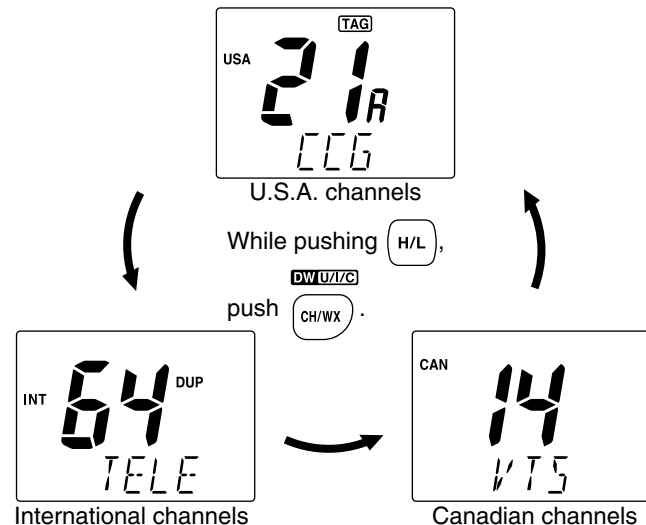

■ Receiving and transmitting

- ① Push [**PWR**] for 2 sec. to turn power ON.
- ② Set the audio and squelch levels.
 - ➔ Push [**SQL**• **MONI L**], then push [**▼**] until the noise appears.
 - ➔ Push [**VOL**• **DIM PA/RX** 40], then push [**▲**] or [**▼**] to adjust the audio output level.
 - ➔ Push [**SQL**• **MONI L**], then push [**▲**] until the noise disappears.
- ③ To change the channel group, push [**CH/WX**• **DW U//C**] while pushing [**H/L**]. (p. 44)
- ④ Push [**▲**] or [**▼**] to select the desired channel. (p. 44)
 - When receiving a signal, "**BUSY**" appears and audio is emitted from the speaker.
 - Further adjustment of the audio level may be necessary.
- ⑤ Push [**LO/DX**• **IC SCR**] to turn the receive Attenuator function ON or OFF, if necessary.
 - "**LOCAL**" appears when the receive Attenuator function is in use.
- ⑥ Push [**H/L**] to select the output power if necessary.
 - "**LOW**" appears when low power is selected.
 - Choose low power for short range communications, choose high power for longer distance communications.
 - Some channels are for low power only.
- ⑦ Push and hold [**PTT**] to transmit, then speak into the microphone.
 - "**TX**" appears.
 - Channel 70 cannot be used for transmission other than DSC.
- ⑧ Release [**PTT**] to receive.

Simplex channels, 3, 21, 23, 61, 64, 81, 82 and 83 **CANNOT** be lawfully used by the general public in U.S.A. waters.

IMPORTANT: To maximize the readability of your transmitted signal (voice), pause a few sec. after pushing [**PTT**], hold the microphone 2 to 4 inches (5 to 10 cm) from your mouth and speak at a normal voice level.

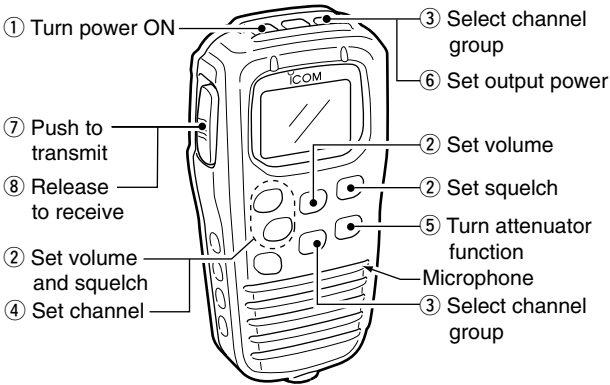

Call channel programming

- ① While pushing [H/L], push [CH/WX•DW U/I/C] several times to select the desired channel group (USA, INT, CAN) to be programmed.
- ② Push [16•9] for 1 sec. to select call channel of the selected channel group.
 - “CALL” and call channel number appear.
- ③ Push [16•9] again for 3 sec. (until a long beep changes to 2 short beeps) to enter the call channel programming condition.
 - The channel number and channel group to be programmed blinks.
- ④ Push [▲] or [▼] to select the desired channel.
- ⑤ Push [16•9] to program the displayed channel as the call channel.
 - The channel number stops blinking.
 - Push [CH/WX•DW U/I/C] to cancel.

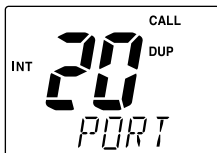
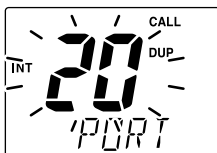
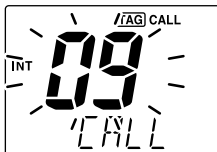
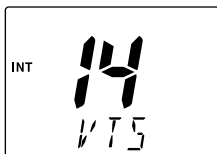

Lock functions

The Lock function electronically locks keys and switches to prevent accidental changes and function access from the microphone.

- All keys, switches and controllers on the transceiver are functional.

◇ Activating the Lock function

- While pushing [H/L], push [SQL•MONI L] to turn the Lock function ON or OFF.

- “” appears.
- Only [PWR], [PTT], [H/L], [SQL•MONI L], [VOL•DIM PA/RX ◀▶], +[▲] or [▼] and [SQL•MONI L]+[▲] or [▼] are functional.

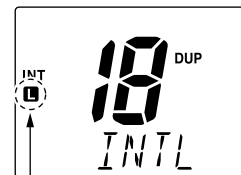

Appears

◇ Activating the All Key Lock function

- While pushing [H/L], turn the power ON by pushing [PWR] to turn the All Key Lock function ON or OFF.

- “” blinks.
- Only [PWR] and [PTT] are functional.

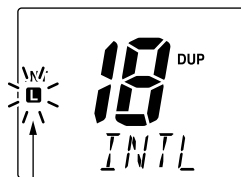

Blinks

■ Display backlight

The function display and keys can be backlit for better visibility under low light conditions. The backlighting condition can also be adjusted independently from the transceiver.

- ① Push [**VOL** • **DIM** **PA/RX** ◀] for 1 sec. to enter the backlight adjusting mode.
 - “**BL**” with the number of the backlight level appears in the channel comment indicator.
- ② Push [**▲**] or [**▼**] to adjust the backlight level.
 - The backlight is adjustable in 7 levels and OFF.

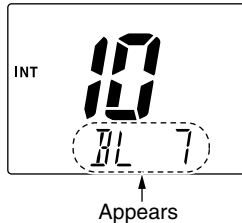

■ Monitor function

The monitor function releases the noise squelch mute of the microphone only. (An independent noise squelch system is employed.)

- ➔ Push [**SQL** • **MONI** **L**] for 1 sec. to activate the Monitor function.
 - “**BUSY**” blinks and audio is emitted.
 - Any key cancels the Monitor function.

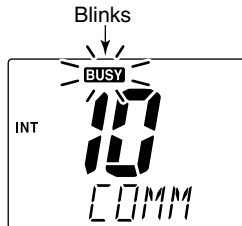

■ Dualwatch/Tri-watch operation

- ① Select Dualwatch or Tri-watch in Set mode. (P. 33)
- ② Push [**▲**] or [**▼**] to select the desired channel.
 - While pushing [**H/L**], push [**CH/WX** • **DW** **U/I/C**] several times to select the channel group (USA, INT, CAN), if desired.
- ③ Push [**CH/WX** • **DW** **U/I/C**] for 1 sec. to start Dualwatch or Tri-watch.
 - “**DW**” or “**Tri**” blinks at the channel comment indicator during Dualwatch or Tri-watch, respectively.
 - A beep tone sounds when a signal is received on Channel 16.
 - Tri-watch becomes Dualwatch when receiving a signal on the call channel.
- ④ To cancel Dualwatch or Tri-watch, push [**CH/WX** • **DW** **U/I/C**] again.

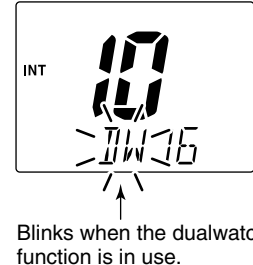

■ Setting TAG channels

- ① While pushing [H/L], push [CH/WX• **DW** U/I/C] several times to select the desired channel group (USA, INT or CAN).
- ② Push [▲] or [▼] to select the desired channel to be set as a TAG channel.
- ③ Push [SCAN• **TAG**] for 1 sec. to set the displayed channel as a TAG channel.
 - “TAG” appears in the display.
- ④ To cancel the TAG channel setting, repeat step ③.
 - “TAG” disappears.

✓ Clearing (or setting) all tagged channels

While pushing [H/L], push [SCAN• **TAG**] for 3 sec. (until a long beep changes to 2 short beeps) to clear all TAG channels in the channel group.

- Repeat above procedure to set all TAG channels.

■ Starting a scan

Set scan type (Priority or Normal scan) and scan resume timer in advance, using Set mode. (p. 32)

- ① While pushing [H/L], push [CH/WX• **DW** U/I/C] several times to select the desired channel group (USA, INT or CAN).
- ② Set TAG channels as described at left.
- ③ Make sure the squelch is closed to start a scan.

- ④ Push [SCAN• **TAG**] to start Priority or Normal scan.

- “SE 16” or “SCAN” appears at the channel comment indicator during Priority or Normal scan, respectively.

- When a signal is detected, scan pauses until the signal disappears or resumes after pausing 5 sec. according to the Set mode setting (Channel 16 is still monitored during Priority scan).
- Push [▲] or [▼] to check the scanning TAG channels, to change the scanning direction or resume the scan manually.
- “16” blinks at the channel comment indicator and a beep tone sounds when a signal is received on Channel 16 during Priority scan.

- ⑤ To stop the scan, repeat step ④.

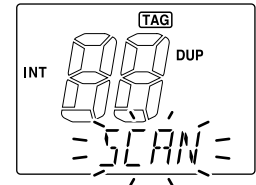

During normal scan.

■ Set mode programming

Set mode is used to change the condition of the transceiver's functions and the microphone's own functions:

Transceiver's functions—

Scan type, Scan resume timer, Weather alert, Dual/Tri-watch, Beep tone*¹, LCD backlight*¹, LCD contrast*¹ and Radio PWR.

Microphone's own functions—

Beep tone*², LCD backlight*² and LCD contrast*²

*¹ For transceiver setting

*² For microphone setting

In this section, instructions are for the microphone's own functions only. Refer to pgs. 32 to 34 for the setting of the other functions. (Some functions cannot be selected from the HM-157.)

◇ Entering Set mode

- ① Turn power OFF.
- ② While pushing [**16•9**], turn power ON.
 - After a beep emission, a Set mode item appears at the channel comment indicator.
- ③ After the display appears, release [**16•9**].
- ④ Push [**16•9**] to select the desired item, if necessary.
- ⑤ Push [**▲**] or [**▼**] to select the desired condition of the item.
- ⑥ Turn power OFF, then ON again to exit Set mode.

• Beep tone

You can select the silent operation by turning beep tones OFF or you can have confirmation beeps sound at the push of a key by turning beep tones ON.



• LCD backlight

The LCD backlight brightness can be adjusted from OFF, 1 (dark) to 7 (bright.)

- “*BACKLIGHT*” scrolls at the channel comment indicator.



Scrolls

• LCD contrast

The LCD contrast can be adjustable in 4 levels. 1 is the lowest contrast, and 4 is the highest contrast.

- “*CONTRAST*” scrolls at the channel comment indicator.



Scrolls

■ Intercom operation

- ① Push [**LO/DX** • **IC** **SCR**] for 1 sec. to activate the Intercom function.
- ② Push and hold [**PTT**] to talk.
 - “*TALK*” appears at the channel comment indicator.
- ③ Release [**PTT**] to listen.
 - “*LSTN*” appears at the channel comment indicator when the transceiver is in talking mode.
- ④ Push [**LO/DX** • **IC** **SCR**] to cancel the Intercom function.
 - Pushing [**16•9**] also cancels the Intercom function.

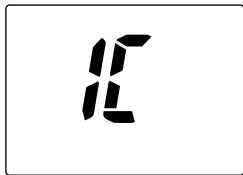

For your reference:

In case the Intercom mode is selected with the transceiver while the microphone power is OFF, the microphone power is automatically turned ON and the Intercom mode is selected.

◇ Intercom beep function

- Push and hold [**LO/DX** • **IC** **SCR**] for more than 1 sec.
 - Emits the Intercom beep while holding.

■ Public Address function

- ① While pushing [**H/L**], push [**VOL** • **DIM** **PA/RX** ◀⁽¹⁾] to enter the Public Address mode.
- ② Push and hold [**PTT**] to talk.
 - “*TALK*” appears at the channel comment indicator.
- ③ Release [**PTT**] to listen.
 - “*LSTN*” appears at the channel comment indicator when the transceiver is in talking mode.
 - To adjust the audio output level, push [**▲**] or [**▼**].
- ④ To cancel the Public Address mode, repeat step ①.
 - Pushing [**16•9**] also cancels the Intercom function.



While in the Public Address mode, the transceiver functions (transmit and receive) are interrupted. If the transceiver is in transmit condition, the Public Address function is not available.

■ RX Speaker function

- ① Push [**VOL** • **DIM** **PA/RX** ◀⁽¹⁾] for 1 sec. to enter the RX Speaker mode.
 - “*RXSP ON*” scrolls at the channel comment indicator.
 - To adjust the audio output level, push [**▲**] or [**▼**] while pushing [**VOL** • **DIM** **PA/RX** ◀⁽¹⁾].
- ② To cancel the RX Speaker mode, repeat step ①.
 - “*RXSP OFF*” scrolls at the channel comment indicator.

■ Channel comments

- ① Push [▲] or [▼] to select a channel to program a channel comment.
 - While pushing [H/L], push [CH/WX• **DW** U/I/C] several times to select the channel group (USA, INT, CAN), if desired.
- ② While pushing [CH/WX• **DW** U/I/C], push [16•9].
 - A cursor and the first character start blinking alternately.
- ③ Select the desired character by pushing [▲] or [▼].
 - Push [SQL] or [VOL• **DM** PA/RX ◀▶] to move the cursor forward or backward, respectively.
- ④ Repeat step ③ to input all characters.
- ⑤ Push [16•9] to input and set the comment.
 - Push [CH/WX• **DW** U/I/C] to cancel.
 - The cursor and the character stop blinking.
- ⑥ Repeat steps ① to ⑤ to program other channel comments, if desired.

• Available characters

⋮ (=)	✳ (*)	† (+)	-- (-)	, (,) . (.)	/ (/)	0 (0)	1 (1)	2 (2)	3 (3)
4 (4)	5 (5)	6 (6)	7 (7)	8 (8)	9 (9) (space)	A (A)	B (B)	C (C)	
D (D)	E (E)	F (F)	G (G)	H (H)	I (I)	J (J)	K (K)	L (L)	M (M)
N (N)	O (O)	P (P)	Q (Q)	R (R)	S (S)	T (T)	U (U)	V (V)	W (W)
X (X)	Y (Y)	Z (Z)	a (a)	b (b)	c (c)	d (d)	e (e)	f (f)	g (g)
h (h)	i (i)	j (j)	k (k)	l (l)	m (m)	n (n)	o (o)	p (p)	q (q)
r (r)	s (s)	t (t)	u (u)	v (v)	w (w)	x (x)	y (y)	z (z)	

■ HM-157 supplied accessories

Accessories included with the HM-157: Qty.

- | | |
|---|---|
| ① Connection cable (OPC-1000: 6 m; 20 ft) | 1 |
| ② Mounting base | 1 |
| ③ Microphone hanger | 1 |
| ④ Screws (M3 × 16; tapping) | 5 |

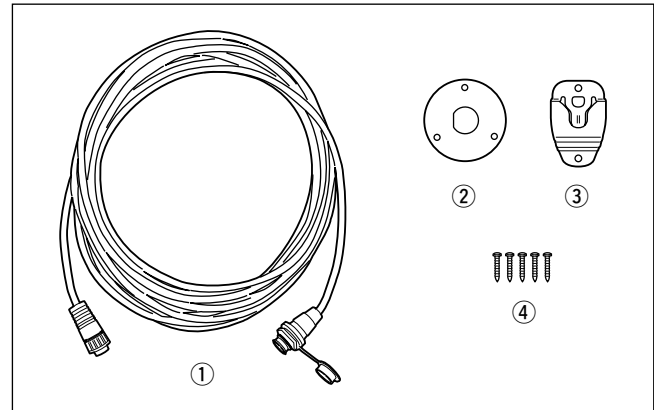

■ Installation

The optional HM-157 can be connected to the transceiver directly, as well as via the supplied connection cable for longer distance remote operation. The connector of the connection cable can be installed into a cabinet, wall, etc., as a built-in plug.

For longer distance remote operation, the optional extension cable, OPC-999 (6 m; 20 ft/connecting between transceiver and the connection cable), is available, and up to 2 OPC-999 can be added.

- ① Insert the supplied cable into the external microphone jack and tighten the cable nut as shown below.

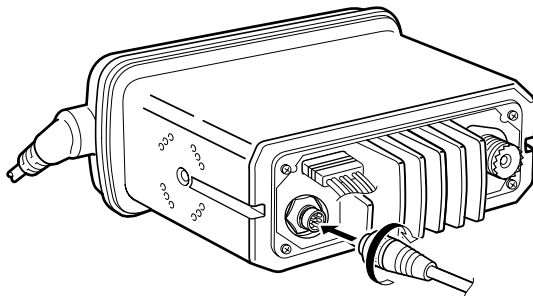

- ② To use the supplied cable as a wall socket, follow the below steps.
- ③ Using the mounting base, carefully mark off the 2 spots where the cable and screws will be fastened.
- ④ Drill holes at these marks.
- ⑤ Install the mounting base using the supplied screws as shown below.

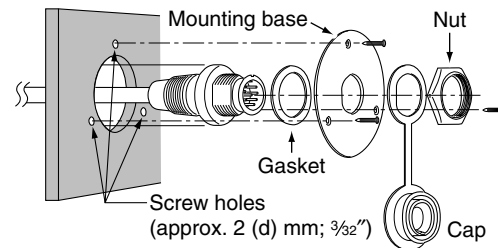

- ⑥ The completed installation should look like this.

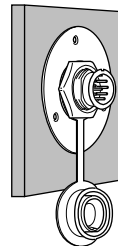

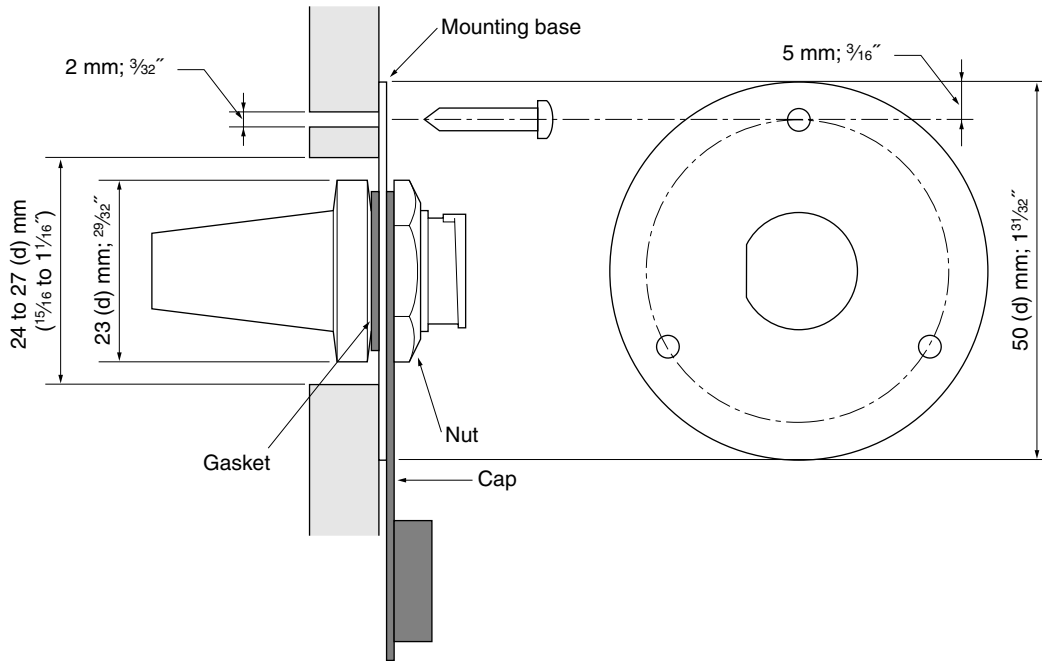

TEMPLATE 14

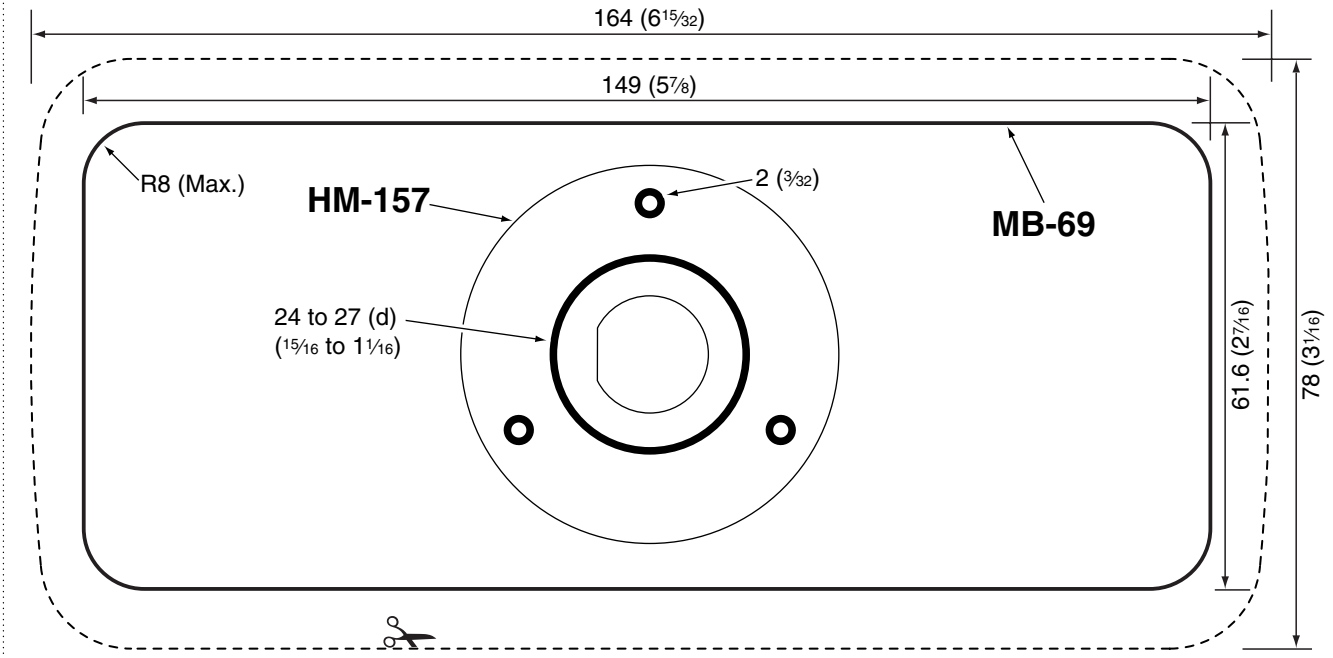

Cut here

Unit: mm (inch)

13
14

Count on us!

A-6431D-1US
Printed in Japan
© 2005 Icom Inc.

Icom Inc.
1-1-32 Kamiminami, Hirano-ku, Osaka 547-0003, Japan